

RRLAPTOP15

W/5mm plywood

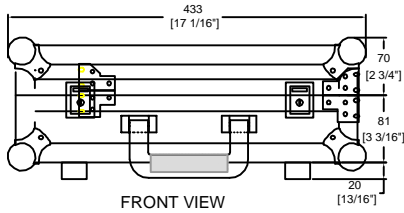

FRONT VIEW

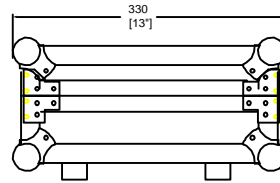

LEFT VIEW

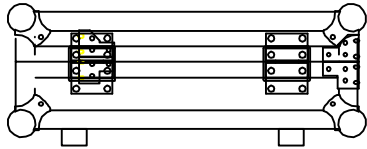

BACK VIEW

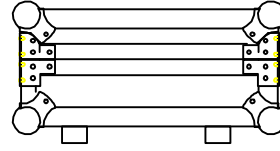

RIGHT VIEW

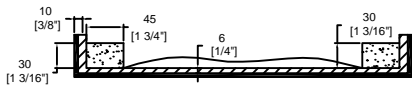

A-A VIEW

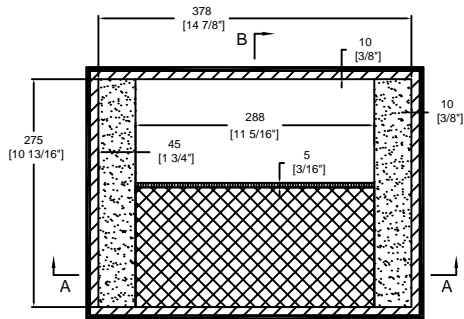
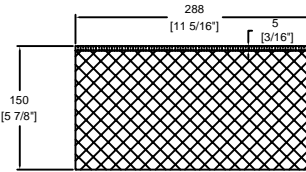

TOP VIEW OF COVER

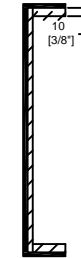

B-B VIEW

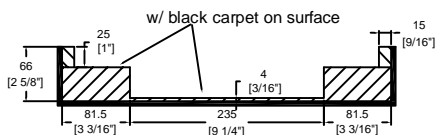
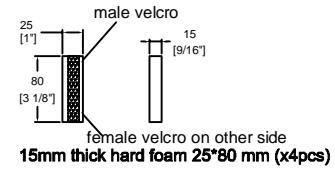
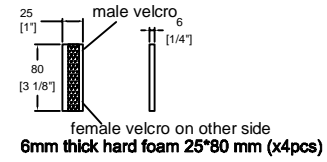

C-C VIEW

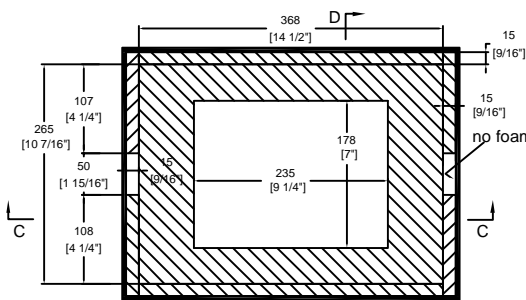
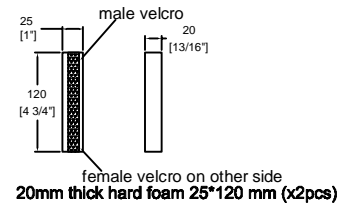

TOP VIEW OF BASE

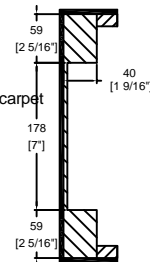

D-D VIEW

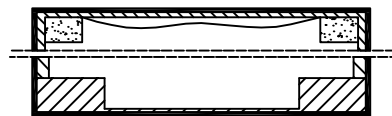

CROSS SECTION

Signature of Approval

Printed Name

2010-09-07