

# Color Video Conference Camera

---

## USER MANUAL



# Video conference camera overview

## Preface

Thank you very much for using our color video conference camera. Please read this manual in detail and use accordingly.

This manual introduce the function of video camera, opening and operation principle in detail.

This color video camera is high-quality and flexibility with a remote pan355° /tilt 120° operation and image flip , and a DSP dealing integration module input. Support VISCA and PELCO P/D protocol.  
Allowing install on the ceiling /desk and a accurate remote control of RS232/485.

## Safety requirement

In order to avoid camera and other connecting equipment damaged and lead to potential danger,

- please follow the rules as below:
- Only professional technician can install and maintenance;  
Prohibit setting on the places which raining or dampness, using unit under stated temperature, humidity and power;
- Using accessories from original factory or allowed;
- Once exchange product or repair happen please use universal meter test before using;
- Please use soft and dry rag for cleaning, no strongly corrosive cleanser for avoiding mangled for outside of camera or lens;
- Take care using and no squeeze crust avoiding camera broken;
- Bracket must be endures 3 times weight of camera at least.

## Features

- 1080p full HD PTZ camera
- Pan 355° , Tilt 120°
- With the latest developed digital signal processor (DSP) improve the image quality of digital zoom
- Multi function IR remote controller can control PTZ, Lens and other function conveniently.
- Using PC to control camera with Sony VISCA or Pelco command
- IR remote controller, RS422C, RS232C and other control method
- 9 preset positions by remote controller, 200 preset positions by PC or remote control unit, memory auto saved when power off
- The maximum speed of horizontal rotation:80° /s, Tilt:60° /s
- Providing multifunctional accurate remote control

# Packing list

Please check up all devices inside while open package.

- Video camera-----1
- Power adapter-----1
- Power cable-----1
- Rs232 cable-----1
- Remote controller-----1
- HDMI wire-----1
- USB wire-----1
- Ceiling bracket-----1

Video camera(1)

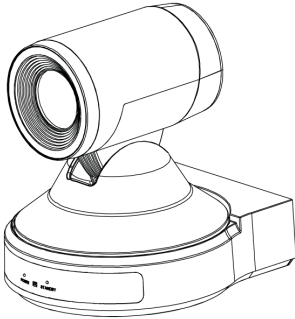

Power adapter (1)

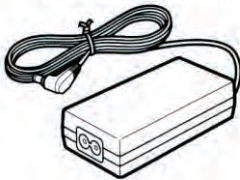

Power cable (1)

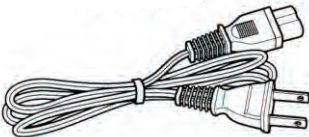

Remote controller (1)



HDMI wire (1)



USB Wire(1)



RS232 cable (1)

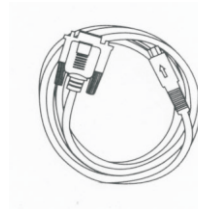

# Parts and Introduction

## Front

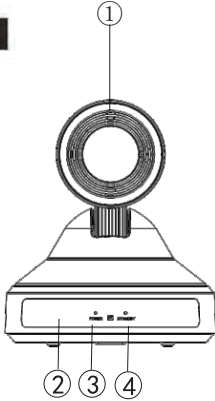

- 1 Lens
- 2 Sensor for the Remote Control
- 3 Power lamp
- 4 Standby lamp

- 5. RJ-45 Network video output
- 6. RS-422C/485 VISCA/PELCO
- 7. HDMI video output
- 8 Line-in
- 9 3G-SDI HD video output
- 10 IR select switch
- 11 USB video output
- 12 VISCA RS-232C IN connector
- 13 DC IN 12V input

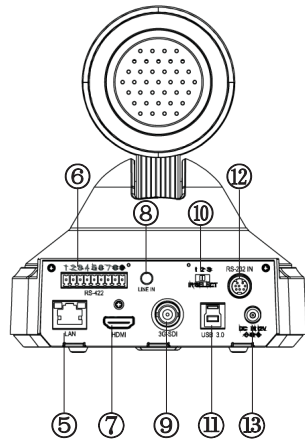

## Bottom

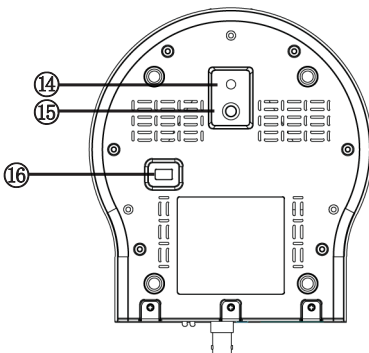

- 14 Local hole
- 15 British screw holes
- 16 VISCA RS-422/RS-232C BOTTOM switch  
(See page 9 for details)

# Remote Controller

- ① CAMERA SELECT: (match to IR SELECT back)
- ② FOCUS: (auto or manual)
- ③ M-OPEN: open the menu
- ④ BACK LIGHT
- ⑤ POWER
- ⑥ STD, REV: (Press L/R DIRECTION SET, and then Press 1 or 2)
- ⑦ POSITION: (Number area; PRESET: press PRESET then press 1-9 for set up preset position)
- ⑧ RESET: (Press RESET and then press 1-9 for eliminate preset position)
- ⑨ ZOOM
  - SLOW T
  - SLOW W
  - FAST T
  - FAST W
- ⑩ PAN-TILT RESET
- ⑪ PAN-TILT ; HOME for return middle position
- ⑫ L/R DIRECTION SET
- ⑬ IR transmit
- ⑭ CLOSE THE MENU
- ⑮ S-OUT: SWITCH TO 720P50
- ⑯ DATA-SCREEN: Switching color mode

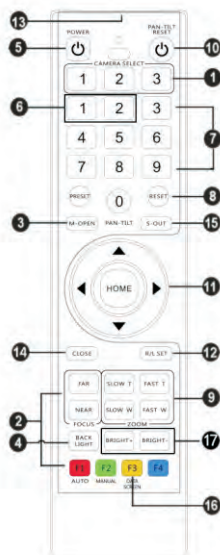

## VISCA RS-422

Pin No.	Function
1	TXD IN+
2	TXD IN-
3	RXD IN+(RS485-)
4	RXD IN-(RS485+)
5	GND
6	TXD OUT+
7	TXD OUT-
8	RXD OUT+
9	RXD OUT-

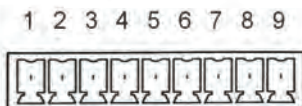

### Attention:

- RS-422 and RS-232 can not be used at the same time

# Maintenance Description

## Remote Commander Operation

### A. Pan/Tilt control

- 1、 Power on, Pan/Tilt will be in initial position.
- 2、 Press arrow for adjust direction, when you can watch video on screen, you can move direction by press arrow step by step or continuously for wild turning direction. If you want to fix direction, please press arrow (up or down) and arrow (left or right) at the same time.
- 3、 Press HOME for front direction.
- 4、 Press PAN-TILT RESET or turn off power and then turn on if direction is not you want, the direction will be change to initial position.
- 5、 Press L/R DIRECTION SET and STD or REV at the same time, meanwhile, move right arrow, you can turn the direction to left or right.

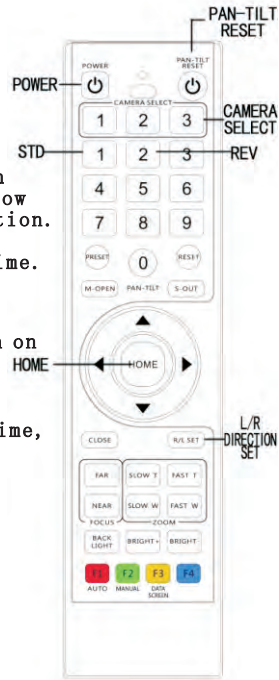

### ■ ATTENTION:

When you use more than one commander, please repeat operat

### B. Adjust Camera

#### ■ FOCUS

- Press AUTO for focus auto
- Press MANUAL and then adjust far or near by switch FAR OR NEAR

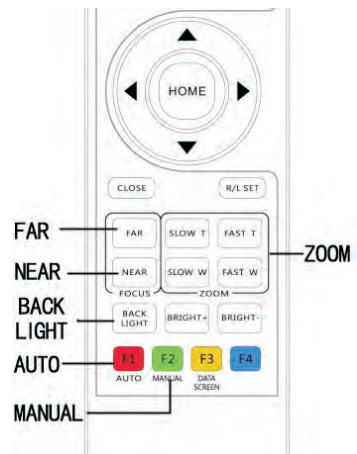

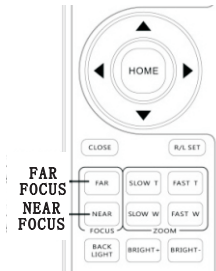

■ **ATTENTION:**

In the condition of far focus, it is natural for the image twitter slowly when operate pan/tilt.

■ **ZOOM**

Adjust T and W for zoom far or near

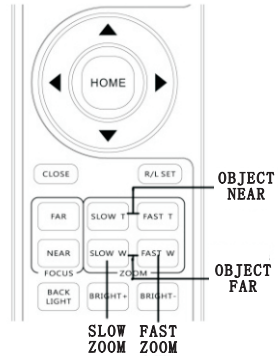

■ **One Remote controller for operating few cameras**

- 1、Maximum 3 cameras can be controlled by a rem controller through back switch 1, 2, 3.
- 2、Press CAMERA SELECT 1 or 2 or 3, you can cont each of matching 1, 2, 3 camera, 1 or 2 or 3 button will be lighted.

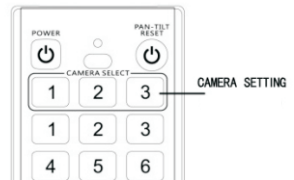

■ **Use back light compensation**

If there is lighting on the back of focusing ob the object will be looks black. So you can pres BACK LIGHT for avoiding this happening, and tu: button for close.

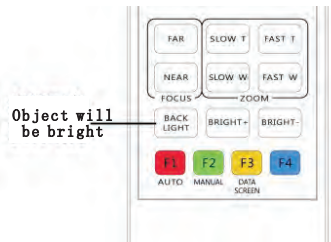

## C、Preset Position Operation

### ■ Store camera settings-presets

Up to 200 presets can be set (location, zoom, focus, and the background light)

By remote controller only can set and calling 9 preset positions.

Through a user-defined protocol Over 200 presets that can be set.

- 1、Recognizes that the STANDBY led is not blinking.  
If the STANDBY indicator is flashing, press PAN-TILT RESET to restored
- 2、Adjust the camera position, zoom, focus, and the background light.
- 3、Press and hold the PRESET button, then press one of the POSITION1-9.

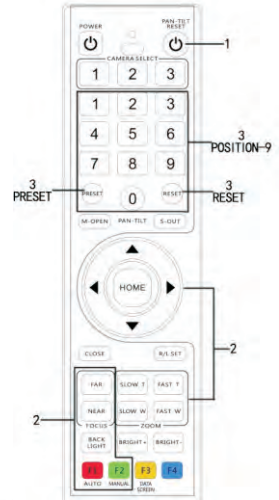

### ■ Use preset position

Press any switch of 1-9 positic

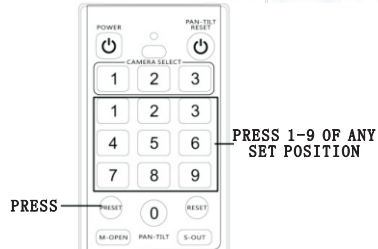

### ■ Cancel preset position

Press RESET, then press 1-9 simultaneou

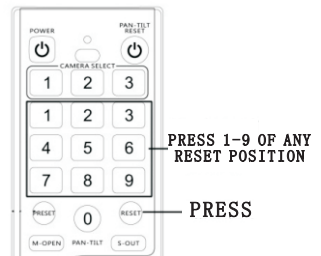

## Attention

If a POSITION is storing or deleting a new set, can not be called in the channel, set or unset.

## Bottom switch

Normal set or ceiling set  
RS232 RS422/485 selection  
the remainder being reserved switc



## BOTTOM SWITCH

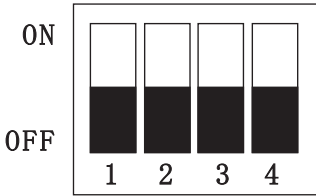

Bottom Switch	Control Selection
1	Upgrade mode
ON	ON
OFF	OFF
2	Upgrade mode
ON	ON
OFF	OFF
3	Install method
ON	Ceiling install
OFF	Normal install
4	Control Method
ON	RS-485/422
OFF	RS-232

Note:

The 1th, 2th bottom switch is for upgrade, do not keep it on while using.

## The Menu

### Communication

communication, Address, baud rate, speed subdivision level, acceleration and other functions. Press right arrow key to enter the corresponding submenu.

### PTZ

This option can set PTZ related functions, including digital zoom, focus Mode, focus sensitivity, remote speed, remote acceleration, preset and other functions. Press the right arrow key to enter the corresponding submenu

### Video format

This option can set the resolution of the conference camera, press the left and right arrow keys to adjust the desired resolution value can be saved by pressing the CLOSE button to exit the menu.

Current resolutions are : 1080P60/50, 1080i60/50, 1080P30/25, 720P60/50

### Image

This option allows you to set image effects, including exposure mode, white balance mode, noise reduction, brightness, saturation, sharpness, gamma value, color image, anti-flicker and other functions.

Press the right arrow key to enter the corresponding submenu

### Language

This option can select the display language of the OSD menu. Currently, it supports three languages: Chinese, English and Traditional Chinese. Converted freely by pressing the left and right arrow keys.

### Version

This option allows you to view the software version number of the conference camera, which can be used by the manufacturer to confirm the version information, without special features.

### Factory Reset

This option restores all optional parameter adjustments of the conference camera to the factory default values. Press the right arrow key to enter the corresponding submenu. Right arrow key to select "OK", then it workable.

MENU	
-----	
Communication>	
PTZ Setting>	
Image Setting>	
Resolution:	1080I50
Language:	English
Version>	
Factory Reset>	
-----	
▲▼ Roll	◆ Change
[HOME]Enter	[CLOSE]Back

# THE MENU

## 1. Communication setting:

```
Communication>
-----
PROTOCOL:      VISCA
ID:            1
BAUD RATE:     9600
Speed Subdivide: 24
Acceleration:  5
-----
  ▲▼ Roll      ◀ Change
[HOME]Enter  [CLOSE]Back
```

Communication submenu:

Protocol: VISCA/PELCO-P/D/VISCA2

Address: set the camera communication address ID

Baud rate: set the serial communication baud rate: 2400/4800/9600/19200/38400/115200

Speed subdivision level: set the speed range of the PTZ movement (only valid for serial port control speed), 1-24/1-64/1-100

Acceleration: set the movement acceleration of the PTZ (only for the serial port control speed is effective), 1-10

## 2. PTZ Setting:

```
PTZ Setting>
-----
DZoom:        OFF
Focus Mode:   AUTO
Remote Speed: 7
Preset Number: 10
-----
  ▲▼ Roll      ◀ Change
[HOME]Enter  [CLOSE]Back
```

PTZ sub menu:

Digital zoom: open / close

Focus mode: automatic / manual / key control

Focus sensitivity: can be set low / medium / high (only for automatic focus mode is in effect)

Remote speed: set the speed of the PTZ movement (only for infrared remote control takes effect), 1-15

Remote acceleration: can set the movement acceleration of the PTZ (only for infrared remote control control), 1-10

Preset position: The maximum number of preset positions supported can be set. Set 10 preset positions and 255 preset positions

## THE MENU

### 3. Image Setting

Image Setting>	
-----	
AE Setting>	
AWB Setting>	
3DNR:	AUTO
Bright:	9
Saturability:	10
Acutance:	3
Next Page>	
-----	
▲▼ Roll	◀▶ Change
[HOME]Enter	[CLOSE]Back

Image Setting>	
-----	
Last Page<	
Gama:	0
Mirror:	OFF
Flick:	50HZ
WDR:	OFF
-----	
▲▼ Roll	◀▶ Change
[HOME]Enter	[CLOSE]Back

Image submenu:

AE setting: set exposure mode, auto / manual / shutter  
Priority/aperture  
priority/brightness priority

White balance: white balance  
automatic / indoor / outdoor / key  
control/ ATW / manual

Noise reduction: set the noise  
reduction value, off / automatic /  
low / medium / high

Brightness: You can set the  
brightness value of the screen, 1-15

Saturation: set the color of the  
picture, 1-14

Sharpness: set the sharpness of the  
screen, range 1-15

Image submenu:

Gamma: set the screen gamma, range  
level 1-4

Mirror: set the left and right  
mirroring effect, on/off

Anti-flicker: adjust anti-flicker  
frequency, off / 50HZ/60HZ

WDR: Adjust wide dynamic range, off  
/ 1-6

# Network Connections

## Connection mode

**Direct connection mode:** Connect the camera directly to the computer with a network cable.

**Network connection mode:** Connect the camera to the Internet network, and access the network through a router or switch. Users can log in to the device through the browser.

The computer must have the network segment where the camera IP is located. If the network segment is not added, you will not be able to log in. If the default IP address of the camera is 192.168.1.118, you need to add 1 network segment to the computer. The specific method is as follows:

First open the computer network local connection properties window, select "Internet Protocol Version 4 (TCP / IPv4)" double click or click the property "Internet Protocol Version 4 (TCP / IPv4)", enter the properties window, click "Advanced" to enter advanced TCP / IP Set the IP address and subnet mask in the IP address field. After the addition is complete, click OK to complete the IP network segment addition. Users can add corresponding network segments according to their modified camera IP address.

## Network login

**WEB login:**

Enter the device IP address in the browser address bar to default to 192.168.1.118, and press Enter to enter the web client login interface. Enter admin in the [User Name] field, enter admin in the [Password] field, and pass the verification to enter the background preview interface.

**Language selection:** Select the language icon in the upper right corner of the login interface, click to select the web interface language type.

## Preview and pan/tilt

**Image preview**

After logging in successfully, enter the management interface. The default is to enter the video preview interface. On the left side of the preview interface, the image preview area, you can click to output the main stream, sub-stream, and the display ratio of the screen output (16:9 & 4:3) and full-screen display function.

**PTZ control:**

On the right side of the preview interface, the PTZ control area can specifically implement the following functions:  
The gimbal rotates upward, the gimbal rotates downward, the gimbal turns to the left, the gimbal rotates to the right, the gimbal restores the initial center position, the lens zooms out, the lens zooms in and the preset position number is set. Number 0 starts counting, which is preset position 1; saves the preset position currently set; deletes the corresponding preset position; calls the corresponding preset position

## Configuration

Click "Settings" in the upper right corner to enter the software parameter configuration interface. There are mainly the following options: video configuration, network configuration, system configuration, etc.

# Configuration

## Video configuration

1), video coding

Encoding mode: Set the video compression format. The default primary/secondary stream compression format is H.264/H.265.

Stream: Set different video output modes and use different streams. Contains primary and secondary streams. The primary stream is optional 1920\*1080, 1280\*720, and the secondary stream is optional 1280\*720, 1024\*576, 640\*360.

## Configuration

Rate (Kb/s): Set the video bit rate (the default stream is 4096Kb/s; the default stream is 2048Kb/s; 0-15360Kb/s is optional)

Frame rate: set the video frame rate, the default frame rate is 30 frames

Rate Control: Set the stream control mode, the primary/secondary stream default variable bit rate (CBR), support for selectable bit rate (VBR)

I frame interval: set the key frame interval, the primary/secondary stream defaults to 30, 1-100 is optional.

## Image parameter

The image parameter interface allows you to make the following adjustments to the image effects:

Focus: You can set the focus mode, focus distance, digital zoom on and off

Exposure: Set exposure mode, shutter speed, anti-flicker, gain, aperture and brightness

White balance: white balance mode, red and blue gain effect can be set

Image: can set mirror, flip, backlight compensation, gamma curve, wide dynamic and other functions

Picture quality: can set the screen brightness, sharpness, contrast, saturation and other functions

Noise reduction: can be set to enable 2D noise reduction, 3D noise reduction

## Network Configuration

### Ethernet parameters

DHCP: Set whether to enable automatic IP acquisition. Close by default

IP address: Set the IP address. The default is 192.168.1.118, where IP is the address of the login web page.

Subnet mask: Set the subnet mask (default is 255.255.255.0)

Default Gateway: Set the default gateway (default is 192.168.1.1)

HTTP port: set the HTTP port, the default is 80

Web port: Set the web port, the default is 6087

Main stream port: Set the main stream video acquisition port. The default is 554.

Secondary stream port: Set the secondary stream video acquisition port. The default is 554.

### System Configuration

Version upgrade: The page displays version information, which can only be read by the user and cannot be modified.

File upgrade: Click the upgrade icon, in the pop-up window, select the upgrade file; click Upload upgrade, after the upgrade is successful, the device automatically restarts. Note: Ensure that the power and network of the device are properly connected during the upgrade process, otherwise the upgrade will fail.

Restore factory: You can select "Simple Recovery" to reset the image parameters, select "Full Recovery" to reset and restart all parameters, and select "Restart" to restart the device directly.

Account setting: You can modify the user name and password of the login management account. After modification, you need to restart and log in again.

## Technical parameter

Image Sensor	SONY 1/2.8" Progressive CMOS	
Effective Pixels	3.1Megapixels	
Resolution HD	1080p60/50, 1080i60/50, 1080p30/25, 720p60/50	
Signal	PAL/NTSC	
Lens	5X optical zoom	12X optical zoom
Foci	f=3.2mm(W)~14.4mm(T)	f=3.9mm(W)~46.8mm(T)
Horizontal View Angle	84.5° (W)~21.6° (T)	72.5° (W)~7.4° (T)
Focus System	Auto/Manual	
Minimum Illumination	0.1Lux	
Exposure Control	Auto/Manual	
Shutter	1/1~1/10000s	
Gain	Auto/Manual	
White Balance	Auto/Indoor/Outdoor/Manual	
Image Effect	Full color/image flip	
S/N Ratio	≥50db	
Pan	355° (max. speed:80° /s)	
Tilt	-30° to +30° (max. speed:60° /s)	
Video Output HD	HDMI、3G-SDI、RJ45、USB2.0/3.0(Optional)	
Power	12V DC(10.8~13.0V DC)	
Protocol	SONY VISCA、PELCO P/D	
Control Mode	RS-232C、RS-485/422、USB Control	
Size	164(L)×164(W)×173(H)	
Weight	1050g	
Accessories	DC 12V power adapter, IR Remote, Operation manual, HDMI Cable, USB Cable, Ceiling	

## Technical parameter

Image Sensor	SONY 1/2.8" Progressive CMOS
Effective Pixels	3.5Megapixels
Resolution HD	1080p60/50, 1080i60/50, 1080p30/25, 720p60/50
Signal	PAL/NTSC
Lens	20X optical zoom
Foci	f=4.7mm(W) ~94.0mm(T)
Horizontal View Angle	58.7° (W) ~3.2° (T)
Focus System	Auto/Manual
Minimum Illumination	0.1Lux
Exposure Control	Auto/Manual
Shutter	1/1~1/10000s
Gain	Auto/Manual
White Balance	Auto/Indoor/Outdoor/Manual
Image Effect	Full color/image flip
S/N Ratio	≥50db
Pan	355° (max. speed:80° /s)
Tilt	-30° to +30° (max. speed:60° /s)
Video Output HD	HDMI、3G-SDI、RJ45、USB2.0/3.0(Optional)
Power	12V DC(10.8~13.0V DC)
Protocol	SONY VISCA、PELCO P/D
Control Mode	RS-232C、RS-485/422、USB Control
Size	164(L) × 164(W) × 173(H)
Weight	1050g
Accessories	DC 12V power adapter, IR Remote, Operation manual, HDMI Cable, USB Cable, Ceiling