

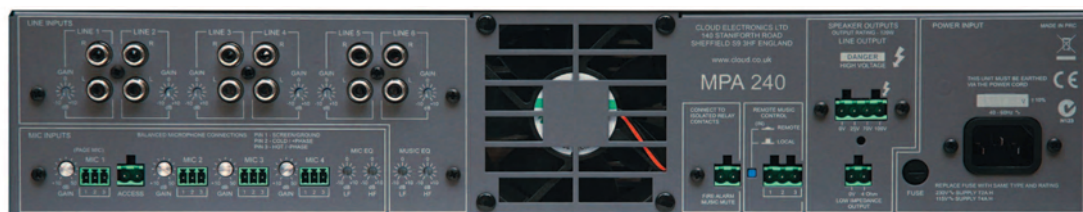

Shown without rack ears



General Description

The increase in demand for higher quality mixed impedance output amplifiers for general installer applications has instigated the launch of Cloud Electronics new MPA Series, MPA240, MPA120 and MPA60, 6 line + 4 microphone inputs into a single zone with configurable 25/70 or 100Volt

- 6 Line inputs, stereo inputs summed to mono
- Line inputs via RCA phono's with input gain controls adjacent to connectors
- Source select via front panel rotary selector or remotely via RSL6
- Line input level via front panel control or remotely via RLI or RSL6
- Line 6 priority selectable by internal jumper; release time 3s/6s/12s selectable by internal jumper
- Music EQ by tamperproof LF & HF presets on rear panel
- 4 Microphone Inputs, low impedance balanced via phoenix style connectors
- Microphone EQ by tamperproof LF & HF presets on rear panel
- 100Hz HP dedicated filter on Microphone inputs
- Phantom power selected by internal jumper for each microphone
- Limiter dedicated to microphone inputs with LED indication
- Mic 1 has access triggered priority over Mics 2 – 4

internal transformer plus the industry standard wall mount remote controllers (RLI & RSL6) make the MPA Series the most flexible and reliable installer amps in the market.

- All mics have VOX priority over music signals, providing 30dB of attenuation (on/off by jumper)
- Integrated chime triggered by access control of Mic 1 (on/off by jumper and level by internal preset)
- Compatible with Bose® SeriesII EQ Cards
- Remote Music Mute configurable for NO or NC operation
- Overall "Peak Limiter" with LED indication on front panel

Amplifier features:

- 63Hz HP Filter for 25/70/100V operation
- Variable speed fan cooling
- Switch on delay
- DC protection
- IV Limiting
- 2U Rack chassis fitted with removable rack ears.

System Example – House of Worship (MPA240/120 or 60)

- The single area has two fixed mic points, lectern 1 & 2 and a Radio Mic to allow the presenter mobility.
- Any of the input sources can be selected and the music level controlled by the RSL-6 at the back of the area.
- The Automatic Source is on line 6 to give priority over all other inputs.
- Dependent on the size of the area the MPA60 (60W), MPA120 (120W) or MPA240 (240W) can be used.
- The output can be configured as 100V/70V or 25V line output (as shown) or low impedance.

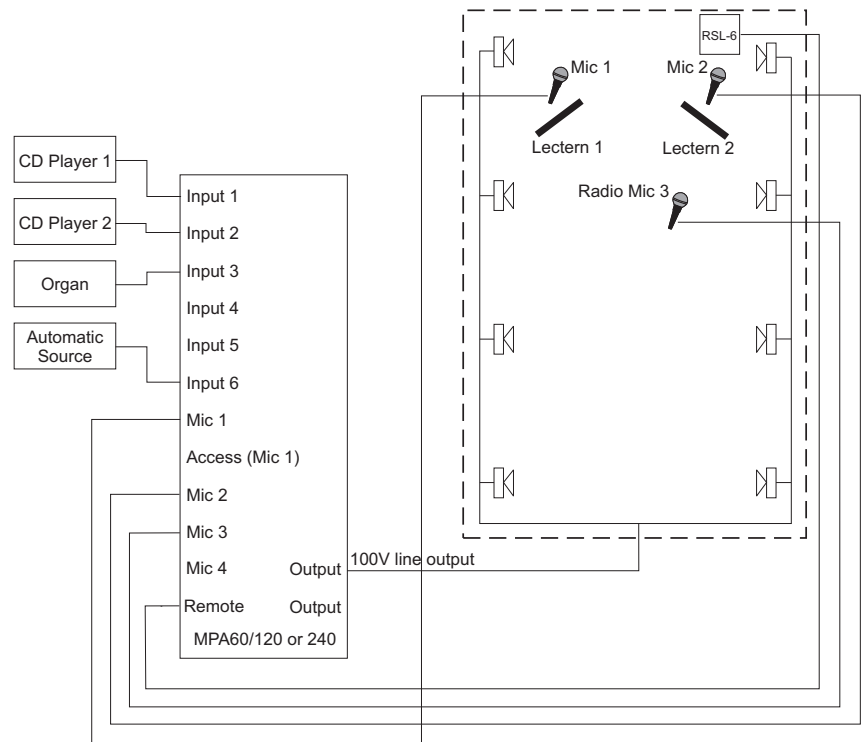

Technical Specifications

Line Inputs

Frequency Response	20Hz +0dB -1dB, 63Hz -3dB 3rd order filter; selectable by jumper 20kHz -1dB low impedance output, 20kHz -2dB 100/70/25V line outputs
Distortion	<0.03% low impedance output <0.04% 25/70/100V outputs @ 1kHz 1dB below full power 80kHz bandwidth
Sensitivity	195mV (-12dBu) to 2V (+8dBu)
Input Gain Control	20dB range
Input Impedance	47k Ω
Headroom	>-20dB
Noise	-90dB _r 22kHz bandwidth, 0dB input Relative to full power output.
Equalisation	HF: \pm 10dB/10kHz LF: \pm 10dB/50Hz

Microphone Inputs

Frequency Response	100Hz / -3dB(3rd order filter) 20kHz +0, -1dB low impedance output 20kHz -2dB 100/70/25V line outputs
Distortion	<0.03% @ 1kHz -1dB below full power 80kHz bandwidth
Gain Range	10dB - 50dB
Input Impedance	>2k Ω (balanced)
Phantom Power	+15V (PCB jumper for on/off)
Headroom	>20dB
Input Noise	-127dB EIN 22Hz - 22kHz (150 Ω)
Equalisation	HF: \pm 10dB/5kHz LF: \pm 10dB/100Hz

Power Output

MPA240	240 Watts, any output @1kHz, <0.07% THD+N
MPA120	120 Watts, any output @1kHz, <0.07% THD+N
MPA60	60 Watts, any output @1kHz, <0.07% THD+N

Power Supply

Power supply	230V/115/100VAC Depending on version	
Mains Fuse rating (20mm x 5mm)	230V version	100/115V version
MPA240	T4A H	T8A H
MPA120	T2A H	T4A H
MPA60	T1A H	T2A H

Cooling & Protection

Cooling	Variable speed fan cooling, air intake on the front of the product, exhaust on the rear
Protection	Fixed level signal limiter with a max gain reduction of 20dB, DC protection, IV limiting & short circuit protection, Switch on delay

Physical

Dimensions	482.6mm (19 inch)x 88.0mm (2U) x 344.5 mm deep (+ connectors & knobs)	
Weight	MPA240	12.6 kg net
	MPA120	10.5kg net
	MPA60	9.0kg net

Graphs

MPA240 100/70/25V Output Frequency Response

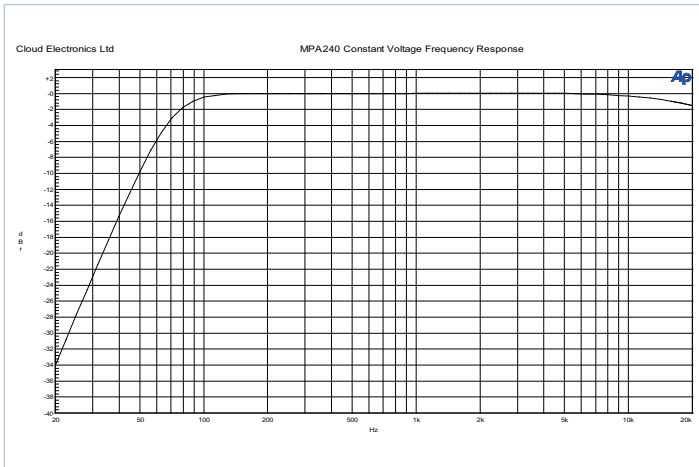

MPA240 Line Input Crosstalk

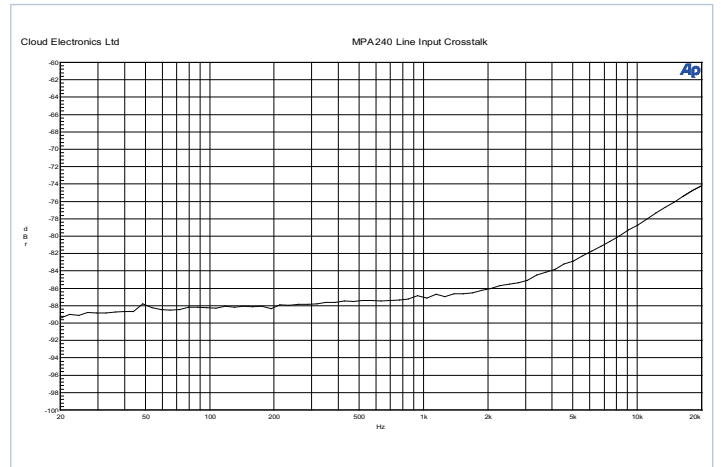

MPA240 Microphone EQ Curves

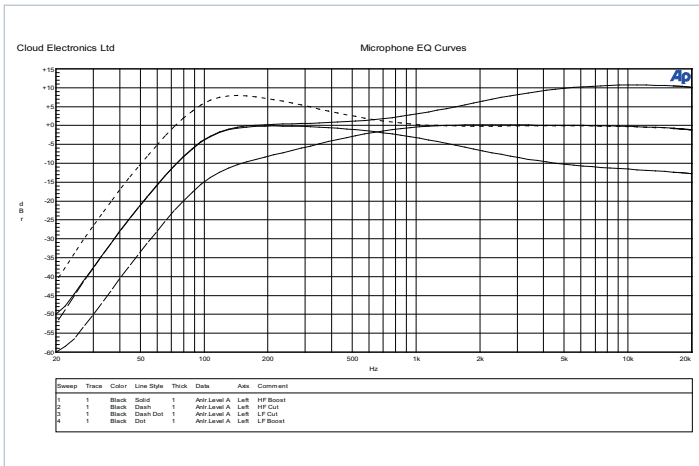

MPA240 Music EQ Curves

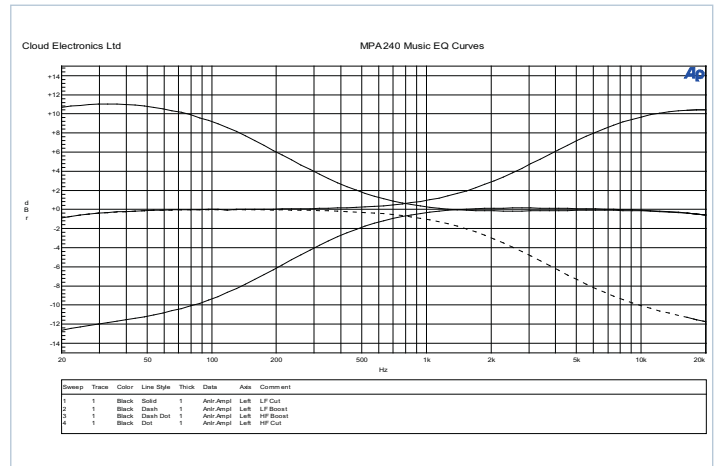

MPA240 Line Input Frequency Response

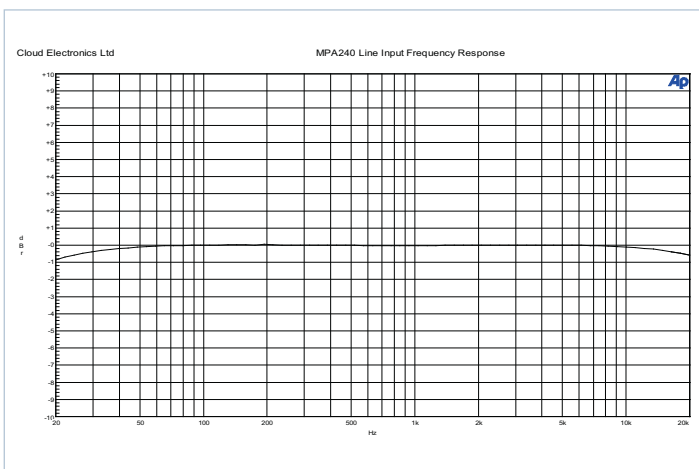

MPA240 Crosstalk: Adjacent Microphone Channels

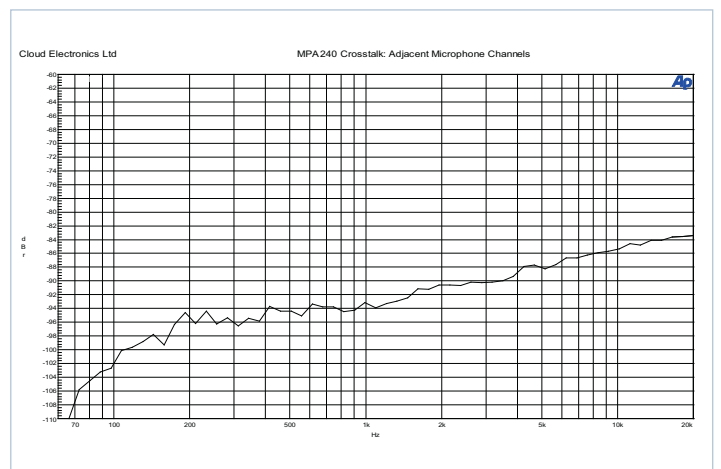

Block Diagram

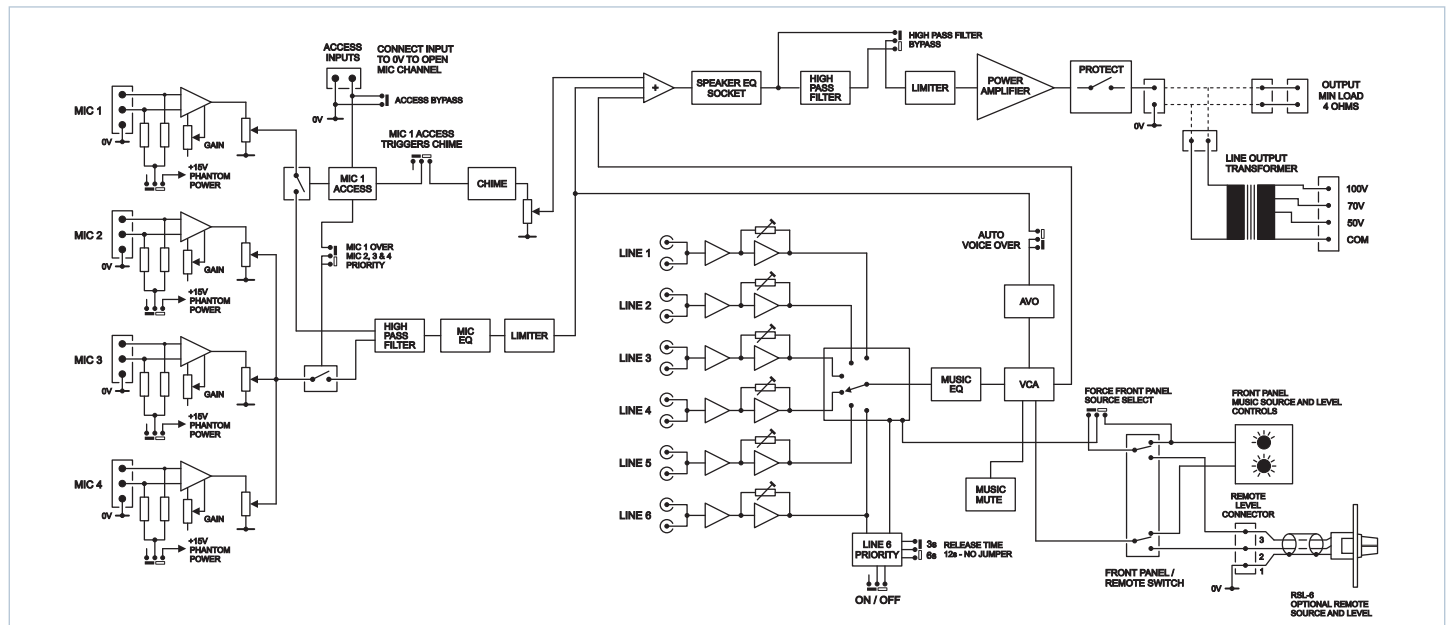

Architect's and Engineer's Specification

The mono mixer-amplifier shall be equipped with six unbalanced stereo music inputs on phono sockets (RCA jacks) and four balanced microphone inputs on multipin connectors. The music input to be used shall be selectable by a 6-position front panel rotary switch. The four mic inputs shall be mixed to a mono signal and summed with a mono (L+R) sum of the selected music input. Each mic input shall have its own front panel level control. It shall be possible to control the level of the music source independently of the mic levels. Each music input and each mic input shall also have a rear panel gain control. 2-band equalisation adjustment shall be provided independently for the selected music source and summed mic signals.

A control input shall be provided to activate one mic input (Mic 1) by external contact closure; it shall be possible to configure the mixer-amplifier such that this function is overridden and Mic 1 is always active. It shall be possible to configure the mixer-amplifier to perform the following additional functions: i) when activated by its control input, Mic 1 will take priority over any other mic input in use; ii) detection of a signal on any mic input will automatically reduce the music level by 30dB, iii) one line input will automatically override all others, even if unselected. Optional remote control panels shall be available to permit control of music level only or music level and input selection; it shall be possible to retrofit these to the mixer-amplifier at any time. An external control input shall be provided to allow muting of the music source by a fire alarm or other external emergency system. The mixer-amplifier will include a chime generator circuit triggered by a signal on Mic 1 input; it shall be possible to internally disable/enable this function.

The microphone mixer stage shall include a high-pass filter to remove background LF noise below 100Hz (-3dB).

A second high-pass filter shall be included to remove LF content below 65Hz (-3dB) from the mixed music and mic signals to minimise transformer saturation in 100V/70V/25V line systems; this filter shall be internally by-passable. Two separate internal fixed limiter circuits shall be fitted; these shall be located at i) the output of the microphone mixer stage and ii) at the input of the power amplifier stage. Operation of either limiter shall be indicated by a front panel LED. The mixer-amplifier shall incorporate protection circuitry that isolates the output i) during power-up, ii) in the event of DC being detected at the amplifier output, iii) if the internal heatsink temperature exceeds 90C (194F).

The mixer-amplifier shall be available in three models with different output powers of 240W, 120W or 60W, into a 4 ohm load. The mixer-amplifier shall be capable of driving either low impedance (4 ohms or higher) loads, or 100V, 70V or 25V line systems via an internal transformer fitted as standard. It shall not be possible to use both types of output simultaneously.

The 100V, 70V and 25V transformer outputs shall be available on separate rear panel output terminals, shrouded by a screw-attached safety cover.

The mixer-amplifier shall accept internal Bose™ Series IIS plug-in equaliser cards to permit use with compatible Bose™ loudspeakers. The mixer-amplifier shall be built in a 2U steel chassis for mounting in a standard 19" rack. Temperature-controlled forced-air fan cooling with front-to-rear airflow shall be employed. The amplifier will be fitted with a front-panel power switch with LED indication.

The mixer-amplifier shall be the Cloud MPA240 (240W output), the Cloud MPA120 (120W output) or the Cloud MPA60 (60W output).