



FOR MEDIUM SIZED SCREENS

BTF844

UNIVERSAL TWIN SCREEN VC STAND

The BTF844 is a premium mounting solution designed to mount two screens side by side for video conferencing applications. A heavy duty steel base eliminates the need to bolt to the floor and adjustable levelling feet are included to accommodate uneven surfaces. The high-end aesthetic with an anodised aluminium finish and integrated cable management ensures finished installations are neat and tidy, making the BTF844 ideal for use in corporate environments.

SPECIFICATION

Recommended screen size	39" - 46"
Max screen width	1068mm per screen
Max load	30kg per screen
VESA and non-VESA fixings	up to 400 x 400mm
Dimensions	W: 1504mm H: 1841mm D: 604mm
Colour options (Column & Rail)	Black or Silver

FEATURES

- Universal design suitable for mounting two screens mounted side by side
- High-end aesthetic quality
- Includes VC shelf which can be fixed above or below the screens
- Heavy duty steel base construction provides stability, eliminating the need to bolt to the floor
- Can also be bolted to the floor to help prevent unauthorised relocation of the display
- Supplied with adjustable levelling feet to accommodate uneven floor surfaces
- Arms feature levelling screws to adjust the screen height
- Collar compatible accessories such as shelves can be fitted directly to the column
- Integrated cable management for a neat and tidy installation
- Safety screws help prevent unauthorised screen removal
- Simple 'hook-on' screen installation

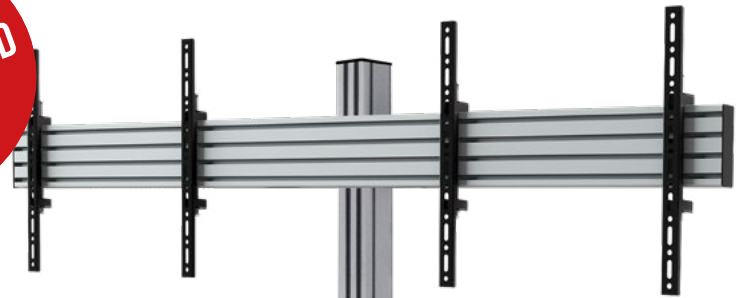

SYSTEM X™



PER SCREEN



Supplied with adjustable levelling feet to accommodate uneven floor surfaces

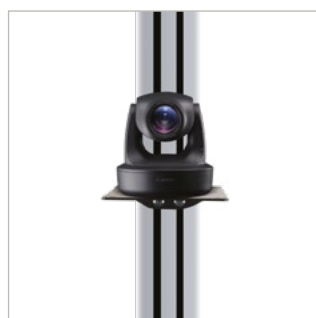

Includes VC shelf which can be fixed above or below the screens (VC camera sold separately)



Collar compatible accessories such as shelves (available separately) can be fitted directly to the column



Integrated cable management for a neat and tidy installation

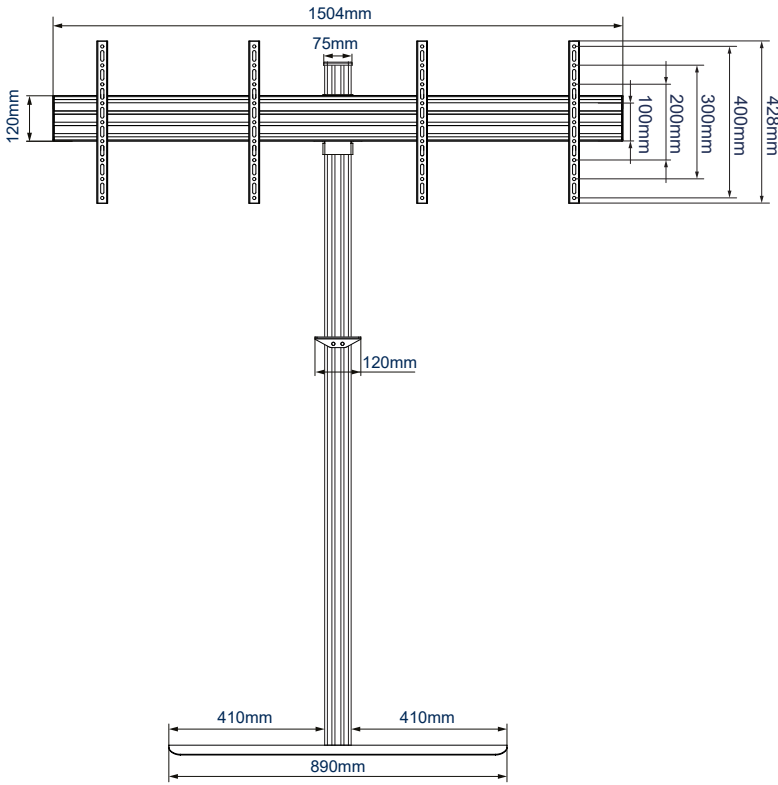

FRONT VIEW

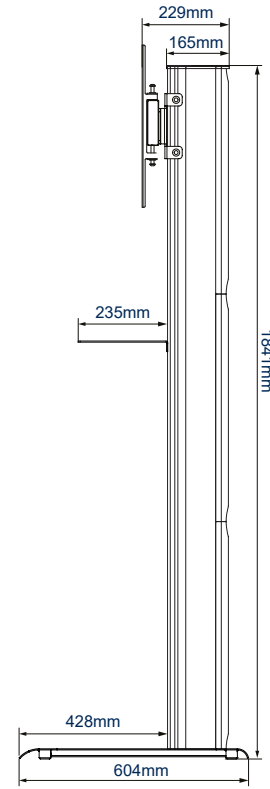

SIDE VIEW

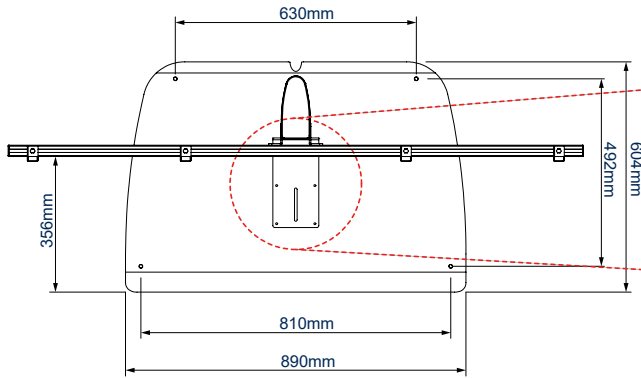

TOP VIEW

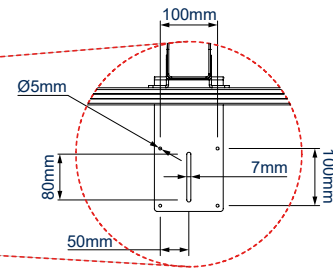

VIDEO CONFERENCE CAMERA SHELF CLOSE UP

PACKING INFORMATION

PLEASE NOTE, THIS IS A MULTI-BOX ITEM

COLOUR:	ORDER REF:	EAN CODE:	MASTER CARTON QTY:	CARTON QTY:	MASTER CARTON WEIGHT:	MASTER CARTON CUBE:
Black	BTF844/BB	5019318087622	N/A	3	20.5kg / 18.7kg /5kg	x2 0.07cbm / x0.01 cbm
Silver	BTF844/BS	5019318087639	N/A	3	20.5kg / 18.7kg /5kg	x2 0.07cbm / x0.01 cbm

ACCESSORIES AND RELATED PRODUCTS

BT7032



Large AV Accessory Shelf is ideal for adding AV accessories such as a Blu-Ray player or laptop to an installation or a wall

BT8390-VESA400T

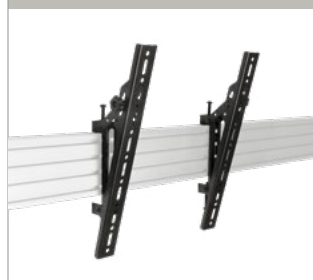

VESA 400 Interface Arms designed to mount medium / large sized screens in a tilted position

BTF841



System X Dual Stack Floor Stand - 1.8m designed to mount two screens, one above the other, in portrait or landscape style

BTF845



System X Twin Screen VC Stand designed to mount two screens side by side in landscape orientation

© 2016 B-Tech Av Mounts. All rights reserved. The information in this specification is subject to change without notice. B-Tech Av Mounts and the B-Tech logo are registered trademarks of B-Tech International Design & Manufacturing Limited. B-Tech Av Mounts is a registered trademark of B-Tech International Design & Manufacturing Limited. B-Tech Av Mounts is a registered trademark of B-Tech International Design & Manufacturing Limited. B-Tech Av Mounts is a registered trademark of B-Tech International Design & Manufacturing Limited. B-Tech Av Mounts is a registered trademark of B-Tech International Design & Manufacturing Limited. SS-V2-BTF844-060819