

See Beyond, LG Transparent OLED Touch Signage

55EW5TF



Astonishing Transparency



Color with Great Depth



Intuitive P-Cap Touch



Product Reliability



* All images are for illustrative purposes only.

A New Level of See-through View

Imagination becomes reality

LG Transparent OLED Touch Signage illuminates spaces that once were hidden away behind the display, completely harmonizing with its surroundings.

Boasting vivid and clear colors with high transparency, this display provides visual enhancements to objects placed behind it, giving viewers an impressive "wow" factor.

Not only that, it can respond according to viewers' touch, which has great potential for various applications where customer interactions are required.

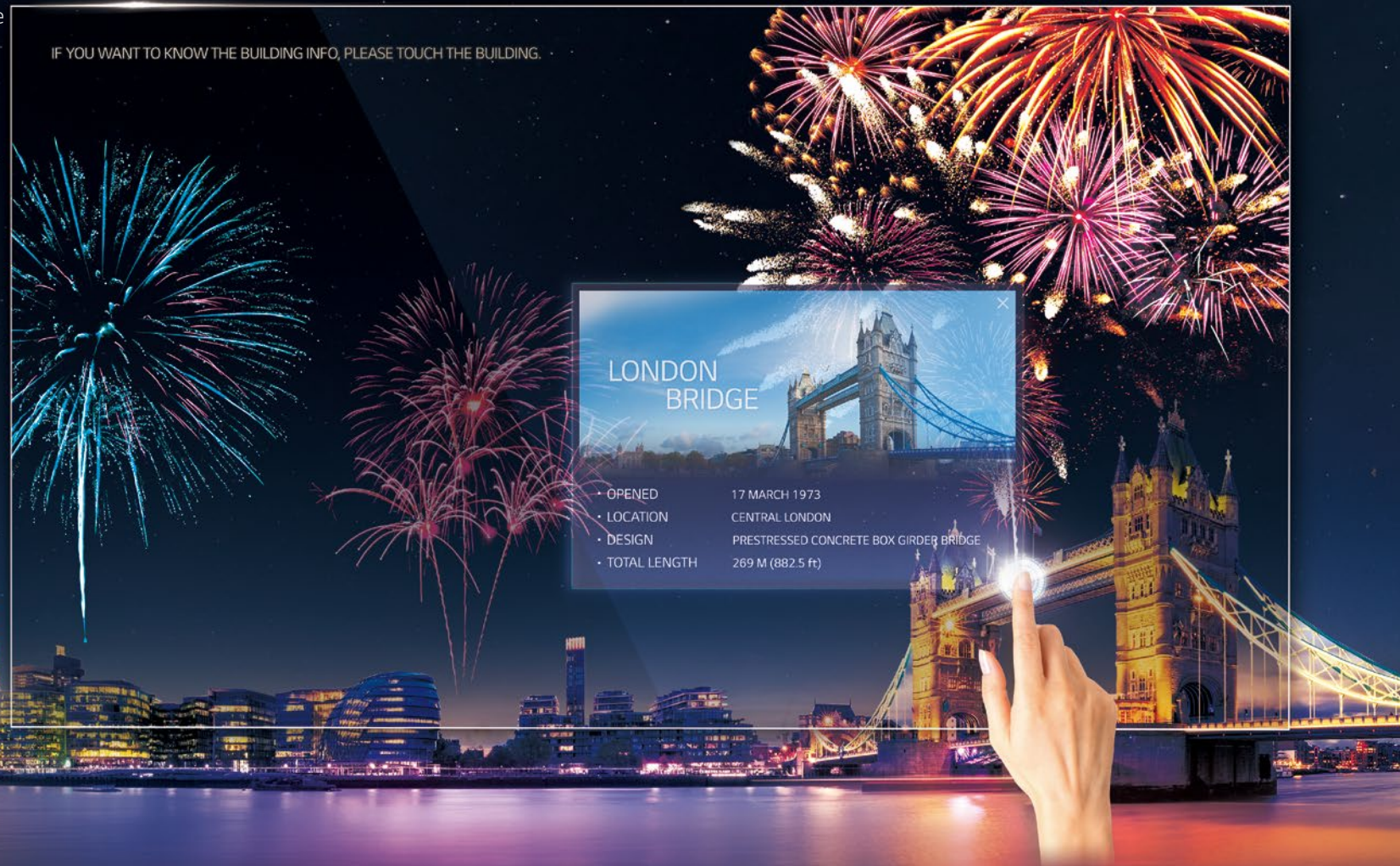

High Transparency

LG's OLED technology makes the Transparent OLED Touch Signage have slimmer structure without backlight unit nor a liquid crystal layer, achieving high transparency of 33% even with P-Cap touch film much higher than conventional LCD transparent displays (10%*). While clearly showing objects behind the screen, it overlays the relevant information right before them.



* Based on LG's WFB series

Accurate and Vivid Colors

Featuring self-lighting pixels, the display maintains vivid colors and high contrast ratio even when the display becomes transparent. It brings content to life from wide viewing angles, and the content blends into its surroundings seamlessly and naturally.



Intuitive P-Cap Touch

By adding P-Cap touch sensor film to the display, the utilization possibilities expand to various industries where customer interaction services are demanding. P-Cap touch type is much better in accurate and fast touch responses than IR type, so users can fully enjoy its fascinating content using their fingertips with no lag.



Protective Tempered Glass

Touching a display directly can cause damage or scratches. The tempered front glass protects product from such external impacts and its anti-shatter glass is designed to minimize customers' injuries.

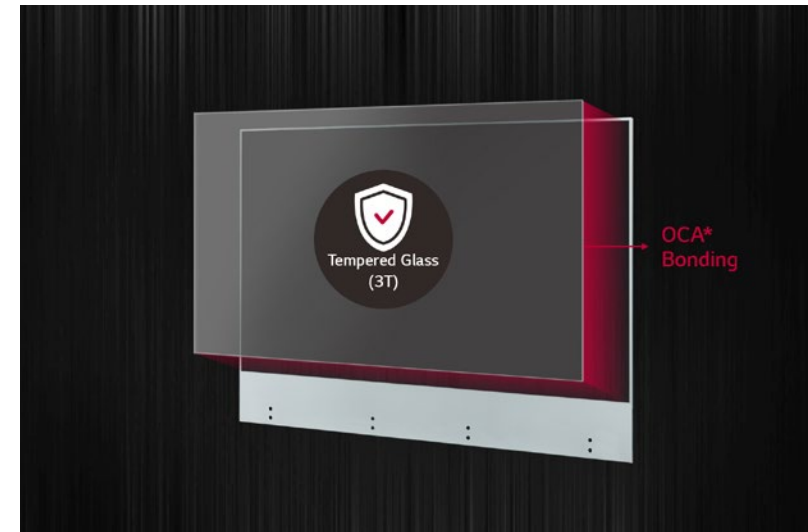

* Optically Clear Adhesive

Expandable Design

LG Transparent OLED Touch Signage is designed as a semi-assembled display, meaning you can install it in various ways to fit into existing structures and spaces. With a variety of forms of installation*, it can complement any venue in which it is installed.

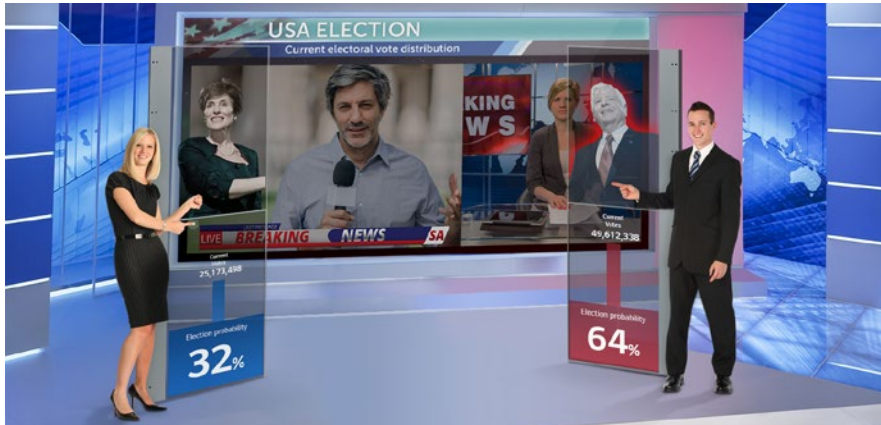
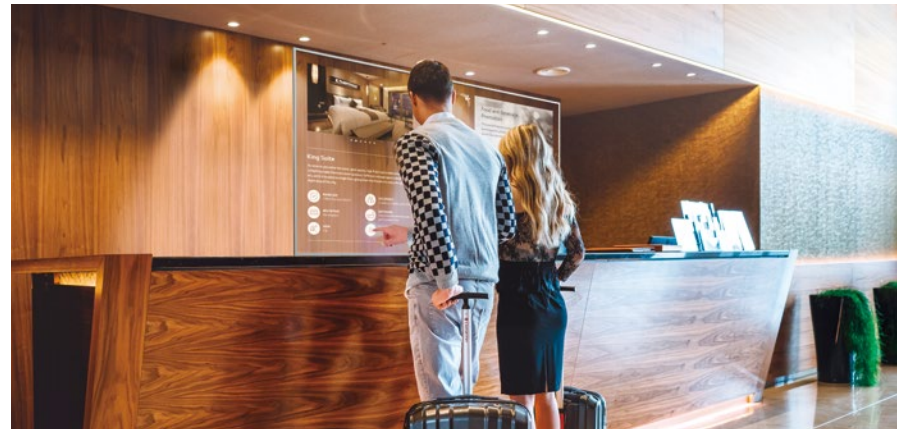
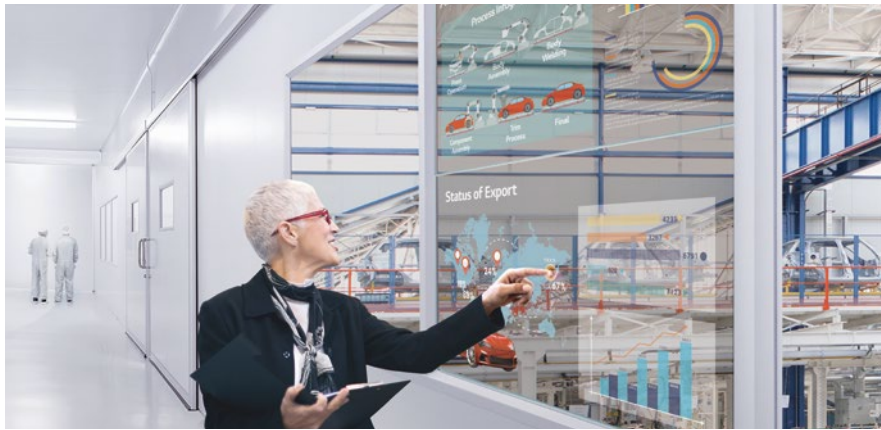

* Installation accessories are not supplied by LG.

DIMENSION (unit: mm)

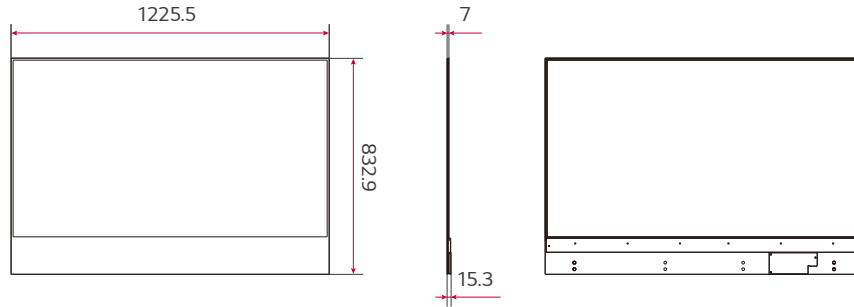

CONNECTIVITY (Signage Box)

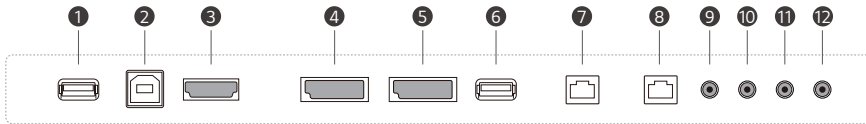

- ① TOUCH USB IN
- ② TOUCH OUT (PC)
- ③ HDMI IN
- ④ DP IN
- ⑤ DP OUT
- ⑥ USB IN (USB 2.0)
- ⑦ LAN IN
- ⑧ LAN OUT
- ⑨ IR IN
- ⑩ RS-232C IN
- ⑪ RS-232C OUT
- ⑫ AUDIO OUT



SPECIFICATIONS

		55EW5TF
Panel	Screen Size	55"
	Panel Technology	OLED
	Native Resolution	1,920 × 1,080 (FHD)
	Brightness (Typ.)	150 / 400 nit (APL 100% / 25 %, W/without Glass)
	Contrast Ratio	150,000 : 1
	Dynamic CR	No
	Color Gamut	BT 709 120 %
	Viewing Angle (H × V)	178 × 178
	Color Depth	1.07 Billion Colors (10bit)
	Response Time	1 ms (G to G)
	Surface Treatment (Haze)	No
	Operation Hours (Hours / Day)	18 / 7 (Moving Content Only)
	Portrait / Landscape	Yes / Yes
	Transparency	33% (Set)
Connectivity	Input	HDMI (HDCP 2.2), DP (HDCP 1.3), USB 2.0 Type A, USB 2.0 Type A (Touch Control Board Only)
	Output	DP, Audio, USB 2.0 Type B (Touch USB)
	External Control	RS232C In / Out, RJ45 (LAN) In / Out, IR In (External IR Receiver)
Mechanical Specification	Bezel Color	Matt Silver
	Bezel Width	7.9 / 7.9 / 7.9 / 144.5 mm (T/ R/L/B)
	Weight (Head)	14.6 kg (Head) / 3.4 kg (Signage Box)
	Monitor Dimensions (W × H × D)	1,225.5 × 832.9 × 7.0 mm (Head) 782.8 × 238.4 × 34.7 mm (Signage Box)
	Monitor Dimensions with Stand (W × H × D)	No
	VESA™ Standard Mount Interface	No
	Protection Glass	Depth: 3.0 mm Tempered / Chemical Strengthening: Yes Anti-Reflective: Yes Shatter-Proof: Yes
Key Features	Internal Memory (16GB), Temperature Sensor, FAN, webOS 4.0, Embedded CMS (Local Contents Scheduling, Group Manager), USB Plug & Play, Fail Over, Video Tag (4), Rotation (Screen Rotation), Gapless Playback, Setting Data Cloning, SNMP, ISM Method, Auto Set ID, Status Mailing, Control Manager, Crestron Connected®, PM Mode, Wake on LAN, HDMI-CEC®, SI Server Setting, ProIdiom	
Environment Conditions	Operation Temperature	0 °C to 40 °C
	Operation Humidity	10 % to 80 %
Power	Power Supply	AC 100 - 240 V -, 50 / 60 Hz
	Power Type	Built-in Power
	Power Consumption	Typ. / Max. 250 W / 280 W BTU (British Thermal Unit) 853 BTU/Hr (Typ.), 955 BTU/Hr (Max.)
Sound	Speaker	No
Certification	Safety	CB, NRTL
	EMC	FCC Class "A" / CE / KC
	ErP	Yes (EU Only)
Media Player Compatibility	OPS Type Compatible	No
	OPS Power Built In	No
Software Compatibility	SuperSign CMS, SuperSign Control / Control+, SuperSign Media Editor, Signage365Care ³⁾	
Accessories (Basic)	Remote Controller, Power Cord, QSG, IR Receiver, Regulation Book, Phone to RS232C Gender, FCC Cables (1,600 mm × 4 ea for Connection Between Panel and Signage Box), HDMI Cable (3 M), Micro to A Type USB Cable (1.8 M for Connection Between Touch and Signage Box), A to B Type USB Cable (Touch Out), Tape (10 ea for Cabling / 10 ea EMI Gasket Tape), Screw (M4 × L22, 12 ea / M4 Nut 12 ea / M3 × L5.5, 8 ea / M3 × L3.5, 20 ea), Shield Cover Ass'y, Rubber Damper 4 ea, Touch Cable Holder 2 ea	

* Dimensions & Jack Panels may differ from the above image, so please contact LG sales team to verify before ordering.

1) Network based control 2) Compatibility may differ by equipment. 3) The availability can differ by region.
* Specification are subject to change without notice, so please contact LG sales team to verify before ordering.



- www.lg.com/b2b
- www.youtube.com/c/LGCommercialDisplay
- www.facebook.com/LGInformationDisplay
- www.linkedin.com/company/lginformationdisplay

LG may make changes to specifications and product descriptions without notice.
Copyright © 2020 LG Electronics Inc. All rights reserved. "LG Life's Good" is a registered trademark of LG Corp.
The names of products and brands mentioned here may be the trademarks of their respective owners.

