

LA12X

user manual (en)

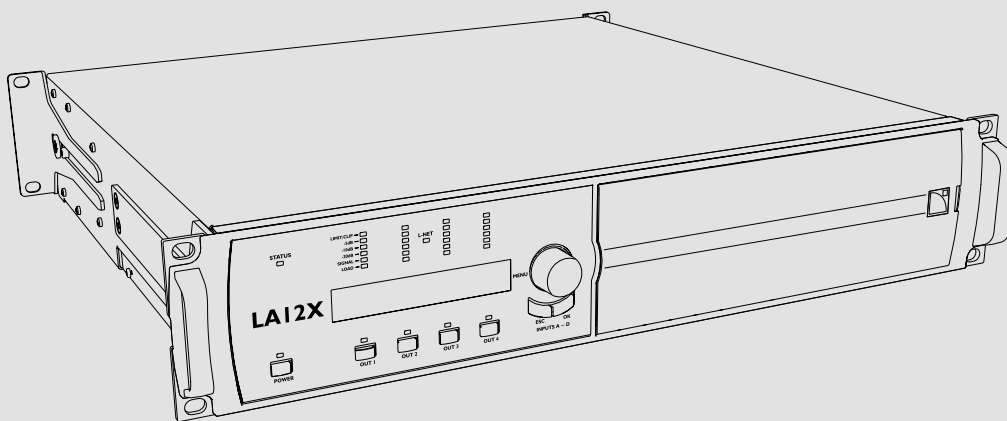

Document reference: LA12X user manual (en) version 1.0

Distribution date: April 21, 2016

© 2016 L-Acoustics. All rights reserved.

No part of this publication may be reproduced or transmitted in any form or by any means without the express written consent of the publisher.

Contents

Safety.....	6
Important safety instructions.....	6
Additional important safety instructions.....	7
Symbols.....	8
System components.....	10
Technical description.....	11
Main features.....	11
Internal components.....	11
Front and rear panels.....	11
Signal processing and amplification.....	12
Signal inputs.....	12
DSP architecture.....	13
Power supply and amplifier section.....	14
Speaker outputs.....	14
Speaker protection.....	14
Monitoring and control.....	14
User interface.....	14
L-NET remote control network.....	14
Installation.....	15
Mounting.....	15
Ventilation.....	16
Connecting to AC mains.....	16
Electrical specifications.....	16
Planning the power of the electrical generator.....	17
Power cord.....	17
Plugging the amplified controller.....	17
Power consumption.....	18
Heat power calculation.....	18
Audio and network cabling.....	18
Connection panels.....	18
Analog audio.....	21
Digital audio.....	22
L-NET.....	23
Speaker.....	23
Operation.....	28
Powering on.....	28

Powering off.....	28
Setting to standby mode.....	29
Interpreting the front panel LEDs.....	29
STATUS.....	29
L-NET.....	29
Meters.....	30
OUT.....	30
Main screen description.....	31
Using quick access functions.....	32
Locking/Unlocking the front panel.....	32
Muting/Unmuting an output channel.....	32
Modifying gain.....	33
Identifying an amplified controller.....	33
Displaying input level, input selection, input mode and group information.....	34
Using the main menu.....	35
LOAD PRESET.....	36
STORE PRESET.....	38
DELETE PRESET.....	39
PRESET PARAMETERS.....	39
CLEAR GROUP PARAMS.....	41
INPUT SETTINGS.....	42
MONITORING & INFO.....	46
OPTIONS.....	48
Settings protection.....	52
Maintenance.....	54
Equipment and tools.....	54
Quality control procedures.....	55
INSP - External structure.....	55
CHK - Cleanness.....	55
CHK - Normal start-up sequence.....	55
CHK - Network functionalities and firmware.....	55
CHK - Sound presence and quality.....	56
CHK - Power capability.....	56
Troubleshooting / diagnosis.....	57
External structure issues.....	57
Interface issues.....	58
L-NET network issues.....	59
Error messages.....	60
Sound issues.....	64
Repair kits.....	66
KR LABRACKET.....	66

KR LA4XGRI.....	66
KR LA4XMOU.....	66
G03285.....	67
G03286.....	67
Procedures.....	68
Exploded view.....	68
D/R - side bracket.....	69
D/R - grill and foam filter.....	70
D/R - rear bracket.....	71
Glossary.....	72
Specifications.....	73
General.....	73
Input Signal distribution.....	74
Analog Input.....	75
Digital Input.....	75
Latency.....	76
Remote control and monitoring.....	76
Physical data.....	76

Safety

Important safety instructions

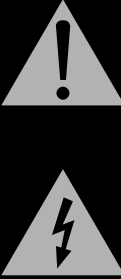
WARNING: RISK OF HAZARDOUS ENERGY SEE OPERATING MANUAL	CAUTION RISK OF ELECTRIC SHOCK DO NOT OPEN		ATTENTION RISQUE DE CHOC ELECTRIQUE NE PAS OUVRI	AVERTISSEMENT: ENERGIE ELECTRIQUE DANGEREUSE VOIR MODE D'EMPLOI
警告: 避免损坏 请严格依照操作手册使用	警告 小心触电 勿打开		주의 감전 위험 열지 마세요	경고: 유해 에너지 위험(고전압) 사용자 매뉴얼 참조
警告: 危険なエネルギーの危険性 取扱説明書を参照してください。	注意 感電の危険 開きません	CUIDADO PELIGRO DE ELECTROCUCIÓN NO ABRIR	ADVERTENCIA: RIESGO DE ENERGÍA PELIGROSA CONSULTE EL MANUAL DE INSTRUCCIONES	
AVISO: RISCO DE ENERGIA PERIGOSA CONSULTE O MANUAL DE FUNCIONAMENTO	ATENÇÃO RISCO DE CHOQUE ELÉTRICO NÃO ABRA	ВНИМАНИЕ РИСК ПОРАЖЕНИЯ ЭЛЕКТРИЧЕСТВОМ НЕ ОТКРЫВАТЬ	ПРЕДУПРЕЖДЕНИЕ: ОПАСНОСТЬ ОПАСНОЙ ЭНЕРГИИ СМ. ИНСТРУКЦИЮ ПО ЭКСПЛУАТАЦИИ	

Explanation of graphical symbols



The lightning flash with arrowhead symbol within an equilateral triangle is intended to alert the user to the presence of uninsulated "dangerous voltage" within the product's enclosure that may be of sufficient magnitude to constitute a risk of electric shock to persons.



The exclamation point within an equilateral triangle is intended to alert the user to the presence of important operating and maintenance instructions in the literature accompanying the product.

1. Read these instructions.
2. Keep these instructions.
3. Heed all warnings.
4. Follow all instructions.
5. Do not use this apparatus near water.
6. Clean only with dry cloth.
7. Do not block any ventilation openings. Install in accordance with the manufacturer's instructions.
8. Do not install near any heat sources such as radiators, heat registers, stoves, or other apparatus (including amplifiers) that produce heat.
9. Do not defeat the safety purpose of the grounding-type plug. A grounding-type plug has two blades and a third grounding prong. The third prong is provided for your safety. If the provided plug does not fit into your outlet, consult an electrician for replacement of the obsolete outlet.
10. Protect the power cord from being walked on or pinched particularly at plugs, convenience receptacles, and the point where they exit from the apparatus.
11. Only use attachments/accessories specified by the manufacturer.
12. Use only with the cart, stand, tripod, bracket, or table specified by the manufacturer, or sold with the apparatus. When a cart is used, use caution when moving the cart/apparatus combination to avoid injury from tip-over.
13. Unplug this apparatus during lightning storms or when unused for long periods of time.
14. Refer all servicing to qualified service personnel. Servicing is required when the apparatus has been damaged in any way, such as power-supply cord or plug is damaged, liquid has been spilled or objects have fallen into the apparatus, the apparatus has been exposed to rain or moisture, does not operate normally, or has been dropped.
15. **WARNING:** To reduce the risk of fire or electric shock, this apparatus should not be exposed to rain or moisture and objects filled with liquids, such as vases, should not be placed on this apparatus.



- 16.** To completely disconnect this equipment from the mains, disconnect the power supply cord plug from the receptacle.
Pour déconnecter complètement l'appareil du secteur, débranchez la prise de la fiche secteur.
- 17.** The main plug of the power supply cord shall remain readily accessible.
La prise principale du cordon d'alimentation doit rester totalement accessible.

Additional important safety instructions



Verify the electrical conformity and compatibility of the mains supply.

Only connect the product to an AC power outlet rated 100-240 V, 50-60 Hz, with the following current values:
100-120 V: 30 A
200-240 V: 16 A

WARNING: The product is of CLASS 1 construction and shall be connected to a mains socket outlet with a protective connection to earth.



When the product is used in a three-phase circuit, verify the electrical conformity and compatibility of the three-phase circuit.

Verify that the three phases work, and balance the loads between the three phases.
Verify that the neutral and earth work.

Never try to emulate a 230 V circuit connecting an apparatus to two live wires of a 120 V three-phase circuit.
Never try to emulate a 200 V circuit connecting an apparatus to two live wires of a 100 V three-phase circuit.



Always interconnect a Class C circuit breaker between the product and the mains supply.

The circuit breaker current rating depends on the mains voltage rating, as follows:
100-120 V: 30 A
200-240 V: 16 A



Electrical generator

You must power on the generator before powering on the product.
Verify that the product is turned off before powering on the generator.



Terminals marked with the lightning flash symbol are HAZARDOUS LIVE.

The external wiring connected to these **terminals** requires installation by an **instructed person** or the use of ready-made leads or cords.

Never attempt to touch any exposed speaker wiring while the product is operating: first disconnect the connector from the product.

Mute all output channels before connecting a speaker to an amplified controller.

Do not connect a speaker output in parallel or series with any output of another amplified controller.

Do not connect the speaker outputs to any other voltage source, such as a battery, power mains, or power supply, regardless of whether the amplified controller is turned on or off.



Never incorporate equipment or accessories not approved by L-Acoustics.

Read all the related PRODUCT INFORMATION documents shipped with the products before exploiting the system.



Beware of sound levels.

Do not stay within close proximity of loudspeakers in operation.







Loudspeaker systems are capable of producing very high sound pressure levels (SPL) which can instantaneously lead to permanent hearing damage to performers, production crew and audience members. Hearing damage can also occur at moderate level with prolonged exposure to sound.

Check the applicable laws and regulations relating to maximum sound levels and exposure times.







Beware of over power risks.

Only use compatible loudspeakers with appropriate presets to avoid damage to the loudspeakers.

-  **Inspect the product before operation.**
If any sign of defect or damage is detected, immediately withdraw the product from use for maintenance.
-  **This product is intended for use by trained personnel.**
-  **Do not use the product outside its operating temperature range.**
The product operates at a room temperature between 0° C / 32° F and 50° C / 122° F.
Do not expose the product to direct sun.
-  **Only use the product in a conformed electro-magnetic environment.**
Conformed environments are specified in EN55103-2 standards as E1 (residential), E2 (commercial and light industrial), E3 (urban outdoors), and E4 (controlled EMC environment, ex. TV studio).
-  **Avoid radio interference.**
This product has been tested and complies with the limits indicated in the EMC directive (Electro Magnetic Compatibility). These limits are designed to provide reasonable protection against harmful interference from electrical equipment, but it cannot be guaranteed that interference will never occur.
-  **Read the maintenance section of this document before servicing the product.**
-  **Shipping**
Use the original packaging for shipping the product, unless it is mounted in a rack with the front and rear panels fixed to the rack, as described in this manual.

Symbols

The following symbols are used in this document:

-  This symbol indicates a potential risk of harm to an individual or damage to the product.
It can also notify the user about instructions that must be strictly followed to ensure safe installation or operation of the product.
-  This symbol indicates a potential risk of electrical injury.
It can also notify the user about instructions that must be strictly followed to ensure safe installation or operation of the product.
-  This symbol notifies the user about instructions that must be strictly followed to ensure proper installation or operation of the product.
-  This symbol notifies the user about complementary information or optional instructions.

Welcome

Thank you for purchasing the L-Acoustics LA12X amplified controller.

This document contains essential information on using the product properly. Carefully read this document in order to become familiar with the product.

As part of a continuous evolution of techniques and standards, L-Acoustics reserves the right to change the specifications of its products and the content of its document without prior notice. Please check www.l-acoustics.com on a regular basis to download the latest document and software updates.

LA12X amplified controller

L-Acoustics amplified controllers offer high performance and efficient loudspeaker amplification, digital signal processing and comprehensive system protection in a single ergonomic package. The onboard preset library allows for rapid system optimization with minimum EQ correction and delivers a unique sonic signature across all L-Acoustics systems.

The LA12X is the most powerful unit in the range. Thanks to its DSP-controlled, universal Switched Mode Power Supply with advanced Power Factor Correction, it delivers high output power with outstanding hold times even on less-than-ideal A/C mains. It offers maximum versatility with its 4x4 architecture and its ability to drive all L-Acoustics loudspeaker enclosures including the KS28 reference subwoofer.

System components

A complete L-Acoustics system includes loudspeaker enclosures, amplified controllers, cables, rigging system, and software applications. The main components of an L-Acoustics system that includes the LA12X are the following:

Loudspeaker enclosures



Refer to the user manuals of the loudspeaker systems for detailed instructions about the enclosures and their connection to the amplified controllers.

Powering and driving system

LA12X	amplified controller with DSP, preset library and networking capabilities
LA-RAK II	touring rack containing three LA12X, LA-POWER II for power distribution and LA-PANEL II for audio and network distribution
L-Case	protection case for L-Acoustics 2U electronics

Loudspeaker cables



Refer to the user manuals of the loudspeaker systems for detailed instructions about the enclosures and their connection to the amplified controllers.

Software applications

LA Network Manager	software for remote control and monitoring of amplified controllers
--------------------	---------------------------------------------------------------------



Refer to the **LA Network Manager video tutorial**.

Illustrations



LA Network Manager



LA-RAK II

Technical description

Main features

Internal components

The core of the LA12X is a dual DSP engine driving four channels of amplification from four inputs. The LA12X also features a flash memory for preset storage and management, high performance A/D-D/A converters and AES/EBU inputs for audio signals, a universal SMPS (Switched Mode Power Supply) with PFC (Power Factor Correction), a front panel user interface, and a 1 Gb/s dual port Ethernet device for networked remote control.

Front and rear panels

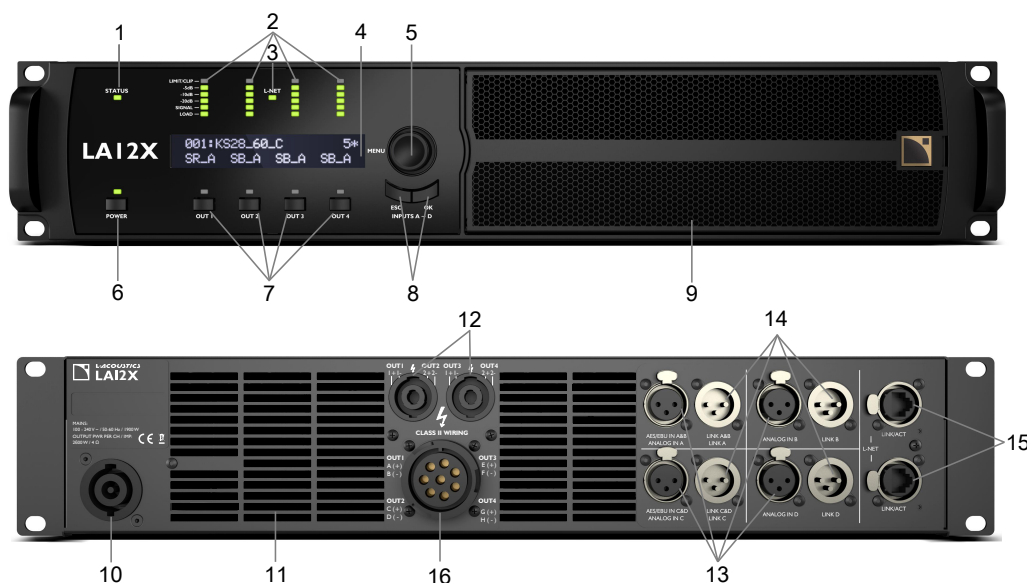

- | | |
|---------------------------------------------------------------------------------------------------------------------------------------------------------------------------------------------------------------------------------------------------------------------------------------------------------------------------------------------------------------------------------------------------------------------------------------------------------------------------------------------------------------------------------------------------------------------------------------------------------------------------------|---------------------------------------------------------------------------------------------------------------------------------------------------------------------------------------------------------------------------------------------------------------------------------------------------------------------------------------------------------------------------------------------------------------------------|
| <ul style="list-style-type: none"> 1 status LED 2 LED meters: <ul style="list-style-type: none"> — LIMIT/CLIP level — audio levels (-5 dB, -10 dB and -20 dB) — SIGNAL presence — LOAD presence 3 L-NET network control LED 4 2 x 24 characters LCD display 5 navigation/editing encoder wheel 6 power/standby key and LED 7 channel selection keys 8 menu keys 9 inward ventilation grill and foam filter | <ul style="list-style-type: none"> 10 powerCON power supply connector (32 A) 11 outward ventilation grills 12 speakON output connectors 13 XLR analog and AES/EBU input connectors 14 XLR analog and AES/EBU link connectors 15 1 Gb/s etherCON L-NET network connectors 16 CA-COM output connector |
|---------------------------------------------------------------------------------------------------------------------------------------------------------------------------------------------------------------------------------------------------------------------------------------------------------------------------------------------------------------------------------------------------------------------------------------------------------------------------------------------------------------------------------------------------------------------------------------------------------------------------------|---------------------------------------------------------------------------------------------------------------------------------------------------------------------------------------------------------------------------------------------------------------------------------------------------------------------------------------------------------------------------------------------------------------------------|

Signal processing and amplification

Signal inputs

The LA12X features four input connectors allowing it to receive four analog signals, four digital signals, or two analog and two digital signals, depending on the input mode selected by the user — see section [INPUT MODE](#) (p.42). This architecture also allows digital-to-analog or digital-to-digital fallback.

Analog inputs

The LA12X can be fed with up to four balanced analog audio signals using XLR female input connectors ANALOG IN A to ANALOG IN D — see illustration in section [Front and rear panels](#) (p.11). Each analog input port is ESD protected.

The analog input panel also features four XLR male link connectors passively wired to the input connectors. They allow transmitting the input signals to daisy-chained amplified controllers. Each analog link port is ESD protected.

To be processed by the DSP, the analog signal must be converted into a digital signal. For this purpose, the LA12X amplified controller is fitted with four cascaded 24-bit A/D converters with a sampling rate of 96 kHz allowing an encoding dynamic range of 130 dB.

AES/EBU digital inputs

The LA12X can be fed with up to four AES/EBU digital audio signals (transported in pairs) using XLR input connectors AES/EBU IN A&B and AES/EBU IN C&D.

Each AES/EBU input port is an XLR female connector. The audio signals can come from a digital mixing desk or a digital audio network bridge compliant with the AES/EBU (AES3) digital audio standards. Each AES/EBU input port is ESD protected and transformer balanced.

The AES/EBU input panel also features two XLR male link ports actively connected to the input ports (with failsafe relay in case of mains absence). They allow transmitting the input signals to daisy-chained amplified controllers. Each AES/EBU link port is ESD protected and transformer balanced.

Each AES/EBU input port is equipped with a SRC (Sample Rate Converter) that has been selected to support a wide range of input formats (16 - 24 bits / 44.1 - 192 kHz). It converts them to the 24 bits/96 kHz internal format used by the amplified controller. The SRC is a high-quality hardware component (140 dB dynamic range, THD+N < -120 dBfs, strong input jitter attenuation) and provides constant propagation delay regardless of the input sampling frequency. There is no external synchronization mode. The amplified controller's clock always runs using its high-precision internal quartz at 96 kHz. This ensures low jitter and high audio quality in live conditions (large cable lengths, large number of amplified controllers) while preventing phase shift, as required for line source systems.



Digital domain benefits

Keeping the signal in the digital domain will provide the following benefits (with any digital mixing desk or any audio network) compared to the analog signal distribution:

- Better audio quality by removing one D/A - A/D cycle
- Better dynamics thanks to the digital links' immunity to ground loops
- Optimized level chain by removing the risk of level misalignment between console and amplified controllers
- Digital signal refreshed at each amplified controller in a daisy-chain
- Improved maximum cable length. The LA12X has been tested with up to 305 m/1000 ft of 3 models of AES/EBU rated cables: 1696A from BELDEN INC., OT234H from KLOTZ communications GmbH, and SC-BINARY 234 from SOMMER CABLE GmbH (single cuts, digital source signal running at $F_s = 48$ kHz)

DSP architecture

The proprietary algorithms allow optimum performance and protection of each individual transducer of the L-Acoustics systems for an even more natural, transparent and realistic sound experience.

- The DSP engine is a 32-bit floating point DSP at 96 kHz sampling rate providing an enhanced dynamic range since it does not generate calculation clips like a fixed point DSP
- A dedicated engineering approach combining IIR and FIR filters generates perfectly linearized phase curves and significantly improved impulse responses
- The 4 x 4 matrix architecture offers flexibility for various system configurations
- A delay of up to 1000 ms can be set for each output channel
- The L-DRIVE transducer protection system offers advanced protection by simultaneously monitoring the excursion and the temperature of the transducer
- With a complete factory preset library and the possibility to create additional user presets, the flash memory provides a quick access to all the usual L-Acoustics speaker system configurations (refer to the **Preset Guide**)

Audio path parameters

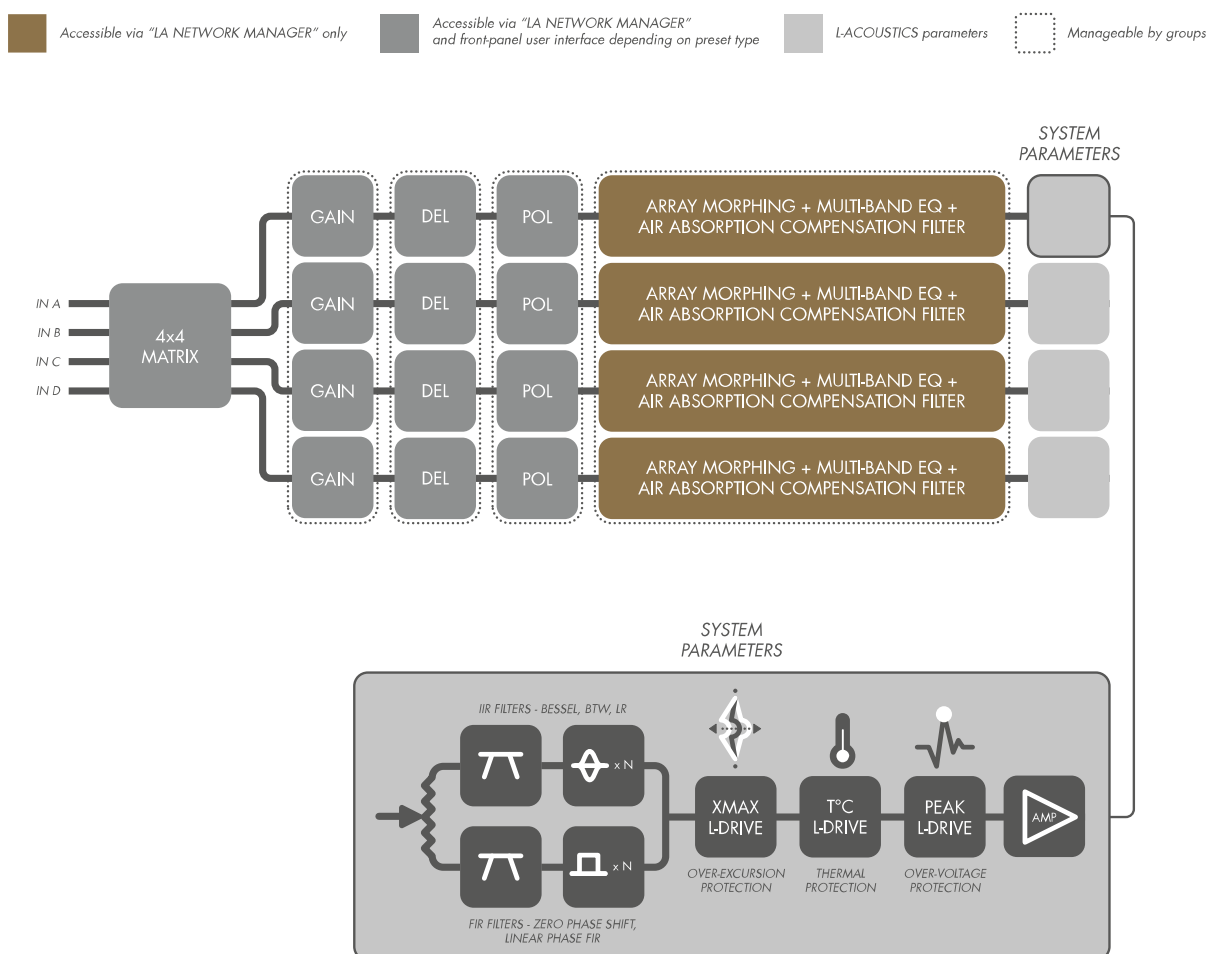

Power supply and amplifier section

The LA12X is a green amplified controller that relies on a universal SMPS (Switch Mode Power Supply) suitable for mains from 100 to 240 V ($\pm 10\%$). The SMPS features a PFC (Power Factor Correction) which maximizes the amplifier efficiency and takes advantage of nearly 100 % of the electrical power available with a very high tolerance to unstable mains. This represents a reduction of the electrical power requirements (cable gauge, power conditioning, etc.) for substantial savings.

The Class D amplification circuits ensure the LA12X energy-efficiency for minimal heat dissipation. LA12X delivers 4 x 1400 W RMS at 8 Ω , 4 x 2600 W RMS at 4 Ω or 4 x 3300 W RMS at 2.7 Ω .

Speaker outputs

The LA12X features two 4-point speakON connectors and one 8-point CA-COM connector for loudspeaker outputs.

Speaker protection

The L-DRIVE transducer protection system provides a dual analysis of both signal intensity and voltage in real-time and RMS. Under extreme conditions, when component membranes reach the over-excursion zone or if the coil temperature reaches a critical point, L-DRIVE is activated and acts as a power regulator.

As a result, the amount of power delivered at any channel is adjusted to the dynamic and thermal capacity of each individual transducer.

Monitoring and control

User interface

The front panel user interface provides:

- real-time monitoring functionalities via the LED display (signals presence and level) and the LCD screen (system parameters)
- instant access to navigation and parameters control using the encoder wheel and the six keys

See also illustration in section [Front and rear panels](#) (p.11).



Operating instructions

Refer to section [Operation](#) (p.28) for detailed operating instructions.

L-NET remote control network

The integration of the L-NET Ethernet-based network, with its high speed data transfer protocol up to 1 Gbit/s, allows up to 253 amplified controllers to be controlled and monitored in real-time from LA Network Manager.

Multiple network topologies such as daisy-chain, star and hybrid are configurable. The computer running LA Network Manager and the amplified controllers are connected to each other using industry standard CAT5e U/FTP cables (or higher category) fitted with RJ45 connectors.

The LA12X connects to the network via the two etherCON sockets located on its rear panel.



Operating instructions

Refer to the **LA Network Manager video tutorial** for detailed operating instructions.



Third party management solutions

L-Acoustics provides SNMP support to facilitate the integration via third party control and monitoring systems. As a certified member of the Crestron[®] and Extron[®] partner programs, L-Acoustics also provides software modules allowing control integration into their automation systems.

Crestron is a trademark or registered trademark of Crestron Electronics, Inc. in the United States, other countries or both.

Extron is a registered trademark of Extron Electronics.

Installation

Mounting

The LA12X is two rack units high (2U) and can be mounted in an EIA-standard 19" rack using the four points on the front panel. Use the fixing material provided by the rack manufacturer to mount the controller to the rack front rails.

LA12X dimensions

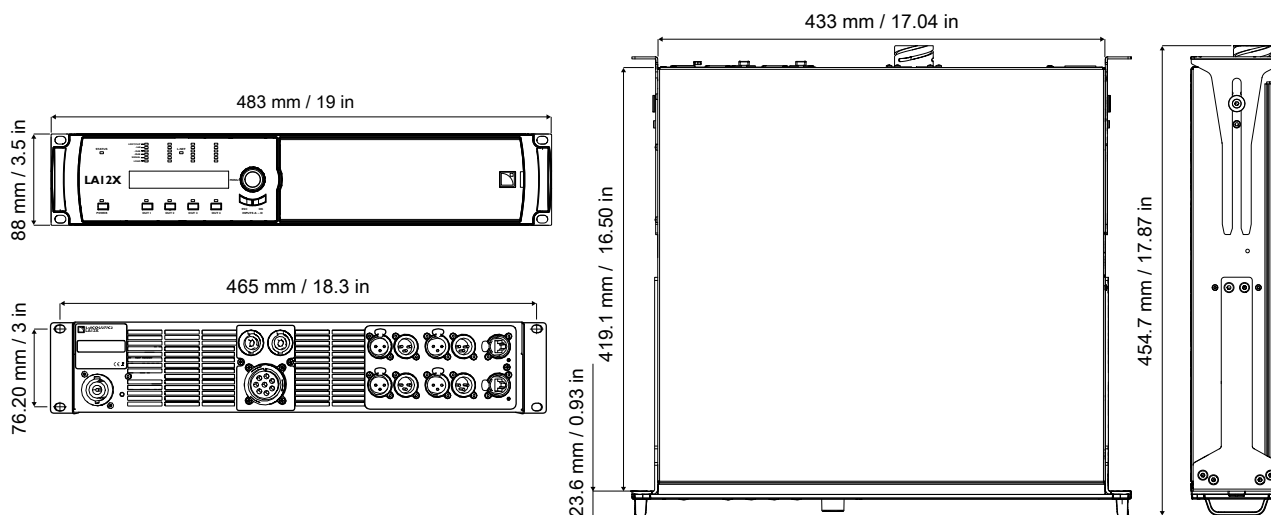

Risk of damaging the amplified controller during transport

During transport or while on tour the amplified controller should be rear supported in addition to the front panel mounting.

Use the rear brackets provided with the controller.

Any mechanical damage to the controller used in portable applications without rear support is not covered by warranty.

LA12X with rear rack support brackets

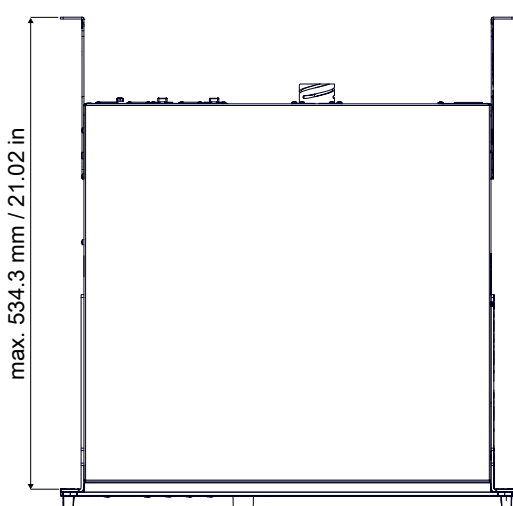

LA-RAK II touring rack

The LA-RAK II touring rack contains three LA12X and panels for power, audio and network distribution. Refer to the **LA-RAK II user manual**.

Ventilation

To maintain moderate operating temperatures, the LA12X is equipped with fans providing front to rear airflow.



Ventilation instructions

Install the controller in an open area so that the front and rear panels are located at a minimum distance of 30 cm from any external object or structure.

Ensure the front foam filter is clean and dirt free.

Do not block the front and rear ventilation grills.

Ventilation when rack-mounted

Do not block the ventilation grills with front or back panels or doors. If not possible, use a forced-ventilation system.

When stacking more than one controller in a rack, mount them directly on top of each other or close any open space in the rack with blank panels.

Connecting to AC mains

Electrical specifications

AC mains specifications



Verify the electrical conformity and compatibility of the mains supply.

Only connect the product to an AC power outlet rated 100-240 V, 50-60 Hz, with the following current values:

100-120 V: 30 A

200-240 V: 16 A

WARNING: The product is of CLASS 1 construction and shall be connected to a mains socket outlet with a protective connection to earth.

Three-phase circuit



When the product is used in a three-phase circuit, verify the electrical conformity and compatibility of the three-phase circuit.

Verify that the three phases work, and balance the loads between the three phases.

Verify that the neutral and earth work.

Never try to emulate a 230 V circuit connecting an apparatus to two live wires of a 120 V three-phase circuit.

Never try to emulate a 200 V circuit connecting an apparatus to two live wires of a 100 V three-phase circuit.

Circuit breaker



Always interconnect a Class C circuit breaker between the product and the mains supply.

The circuit breaker current rating depends on the mains voltage rating, as follows:

100-120 V: 30 A

200-240 V: 16 A

Planning the power of the electrical generator



Electrical generator

You must power on the generator before powering on the product.

Verify that the product is turned off before powering on the generator.

LA12X draws 16 A from 230 V.

A typical generator has a power factor of 0.8 and should operate at 70% load for good efficiency.

The kVA provision for one LA12X should therefore be:

$$(16 \text{ A} \times 230 \text{ V}) / (0.8 \times 70 \%) = 6.5 \text{ kVA}$$

This calculation is an example using typical values. It can be adapted using the table in section [Power consumption](#) (p.18).

Power cord

The removable power cord is fitted at one end with a 32 A powerCON connector.

The other end and the wires color code depends on the cord type, as follows:

type	plug	live	neutral	ground
CE	CEE 7/7, 16 A / 250 V, grounded	brown	blue	green/yellow
CN	GB1002 GB2099, 16 A			
US	NEMA L5-30P, 30 A / 125 V, grounded	black	white	green
INT	bare ends (local power plug to be fitted)	black	white	green/yellow



Strictly apply the specific safety regulations of the country of use.

Do not defeat the ground connection of the supplied power cord using an adaptor or any other methods.

A suitable plug must be wired to the INT power cord.

Verify that the plug conforms to the specific voltage and current rating given in section [Electrical specifications](#) (p.16).

Plugging the amplified controller

How to plug the amplified controller to the AC mains

Procedure

- First, connect the powerCON to the amplified controller mains panel.

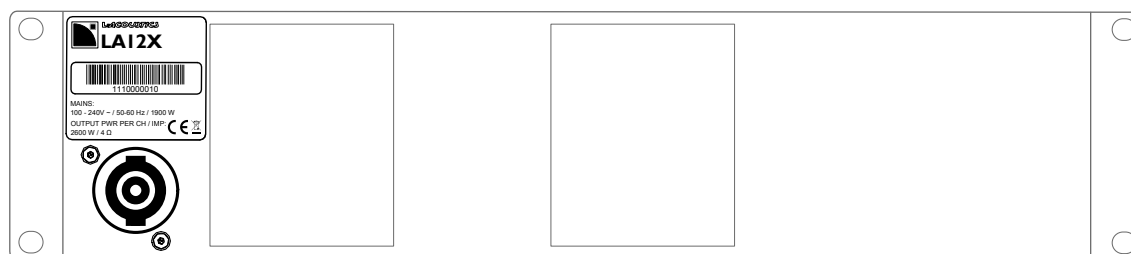

- Then, connect the power plug to the mains socket.
Following this order improves the powerCON longevity.

Power consumption

The LA12X power requirements depend on the load impedance and the signal level.

mains input power and current draw (all channels driven)

maximum output power	4 x 1400 W RMS at 8 Ω	4 x 2600 W RMS at 4 Ω	4 x 3300 W RMS at 2.7 Ω
1/3 output power (-5dB)	10.5 A / 2300 W	19 A / 4200 W	26 A / 5500 W
1/8 output power (-9 dB)	4.8 A / 1050 W	8.1 A / 1850 W	11.5 A / 2400 W
idle	1 A / 160 W	1 A / 160 W	1 A / 160 W
standby	0.6 A / 10 W	0.6 A / 10 W	0.6 A / 10 W

Current values given for mains rated at 230 V. Multiply by:

- 2.3 for 100 V
- 1.9 for 120 V
- 1.15 for 200 V

i Output power references

A third of the maximum output power corresponds to the worst case scenario of a program source using highly compressed music or pink noise with amplified controller driven to clip level.

An eighth of the maximum output power corresponds to a loud music program with a small dynamic range and 9 dB of headroom (IEC standard power rating).

Heat power calculation

If a 4 Ω load is connected to each output channel of the LA12X, each channel delivers up to 2600 W.

With a standard use at 1/8 of full power (9 dB headroom), the power delivered per channel is:

$2600 / 8 = 325$, so a total power of $4 \times 325 = 1300$ W.

According to the table in section [Power consumption](#) (p.18), the LA12X power consumption is 1850 W. The heat power produced is then (difference between power consumption and output power):

$1850 - 1300 = 550$ W

Audio and network cabling

Connection panels

The amplified controller's rear side features three panels for audio and network cabling:

- a speaker panel (1) to connect the loudspeakers
- a signal panel (2) to connect the analog and/or digital (AES/EBU) audio sources and link the signals to another amplified controller
- an L-NET panel (3) to connect to a network and be remotely controlled by LA Network Manager

LA12X audio and network connection panels

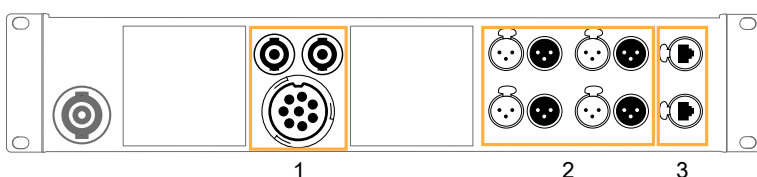

Speaker panel

The two 4-point SpeakON connectors and the 8-point CA-COM connector on the rear panel are for loudspeaker connection. They are wired as follows:

left SpeakON connector		right SpeakON connector	
Pin 1+	Out 1+	Pin 1+	Out 3+
Pin 1-	Out 1-	Pin 1-	Out 3-
Pin 2+	Out 2+	Pin 2+	Out 4+
Pin 2-	Out 2-	Pin 2-	Out 4-

CA-COM connector			
Pin A	Out 1+	Pin E	Out 3+
Pin B	Out 1-	Pin F	Out 3-
Pin C	Out 2+	Pin G	Out 4+
Pin D	Out 2-	Pin H	Out 4-

Output audio paths

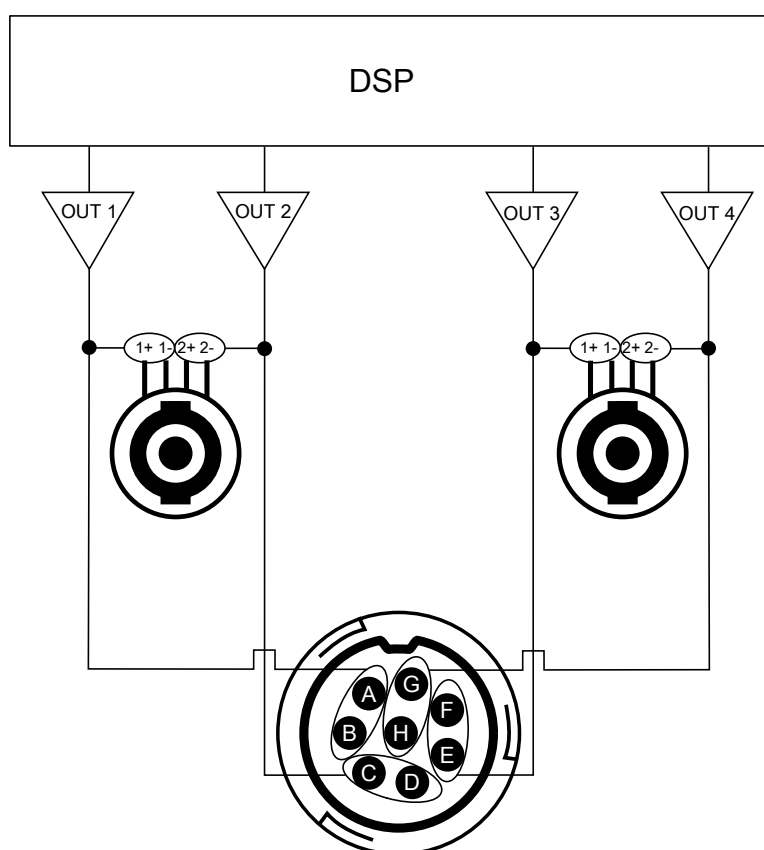

Signal panels

The eight XLR connectors on the rear panel are for analog or digital signal cabling.

The XLR connectors can transport analog or digital signals depending on the input mode selected by the user for channel pairs AB and CD (the two selections can be different). Connections to the IN connectors are referenced in the table. Refer also to section [INPUT MODE](#) (p.42).

Input mode AB	IN A / IN A&B	IN B
Analog	analog audio source (1 channel)	analog audio source (1 channel)
AES/EBU	digital audio source (2 channels)	not used

Input mode CD	IN C / IN C&D	IN D
Analog	analog audio source (1 channel)	analog audio source (1 channel)
AES/EBU	digital audio source (2 channels)	not used

Each LINK connector is wired to the corresponding IN connector, and thus transports the same type of signal.

LA12X signal panel

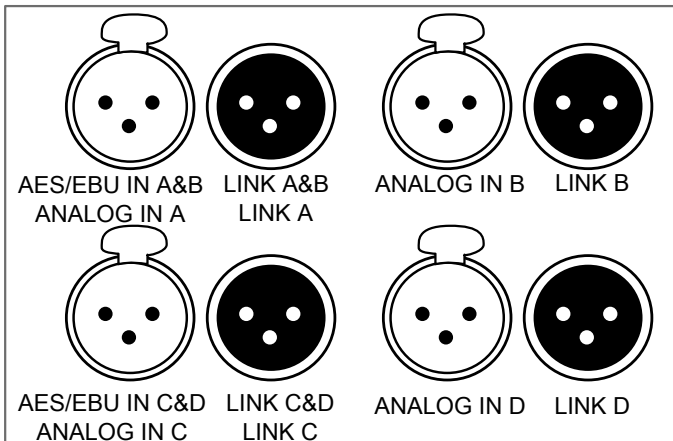

Analog input mode

The XLR connectors are wired according to IEC 60268-12:

- pin 1: shield
- pin 2: + signal
- pin 3: - signal

The female XLR input connectors ANALOG IN A to ANALOG IN D can receive up to four analog signals (when setting the analog input mode for channel pairs AB and CD). The headroom of the input circuits is high enough to accept the maximum output level from virtually any line level signal source (up to 22 dBu).

Each LINK connector is passively wired in parallel to the corresponding IN channel. The input impedance is high enough (22 k Ω , balanced) to allow multiple parallel input connections.

AES/EBU input mode



Digital audio source specifications

Standard: AES/EBU (AES3)

Sampling frequency: 44.1, 48, 88.2, 96, 176.4 or 192 kHz

Word length: 16, 18, 20 or 24 bits

The AES/EBU inputs are transformer balanced and their XLR connectors are wired according to IEC 60268-12.

The female XLR input connectors AES/EBU IN A&B and AES/EBU IN C&D can receive up to four digital signals (when setting the AES/EBU input mode for channel pairs AB and CD). The input format is AES/EBU (AES3).

Each LINK connector is electronically buffered to allow daisy-chaining any number of amplified controllers. It also features a failsafe relay to ensure wiring continuity in case of amplified controller shutdown.

L-NET panel

The two etherCON connectors are for the remote control of the amplified controllers over an Ethernet network called L-NET using LA Network Manager.

Each of the two etherCON connectors can be equally used as an IN or a LINK connector.

Analog audio

i Balanced cables

Symmetrical (balanced) shielded cables are highly recommended as balanced signals are less sensitive to AC hum and radio interference.

Unbalanced lines may add noise especially over long cable runs.

In a daisy-chain layout, the male XLR link connectors LINK A to LINK D feed the input signals to the next amplified controller in the signal chain.

Daisy-chaining analog audio

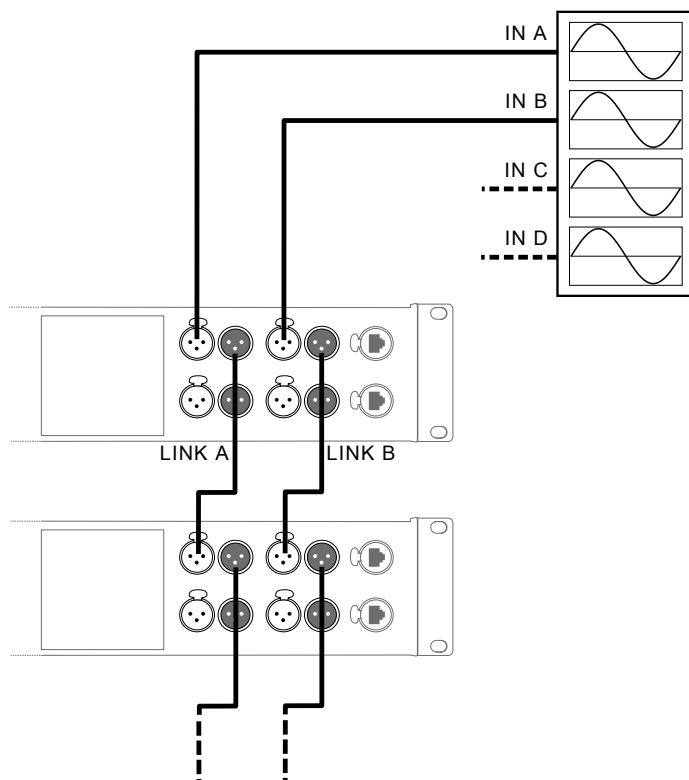

Digital audio



Cables for AES/EBU digital audio

AES3 specifies that the nominal characteristic impedance of cables used for AES/EBU digital audio transmission shall be $110 \Omega \pm 20\%$, and closer tolerances allow for increased transmission reliability over long lengths or higher sampling rates.

Therefore, it is highly recommended to use high-quality AES/EBU rated cables only, although certain cables designed for balanced analog audio prove to be acceptable at 48 kHz sampling rate over short distances.

It is recommended to use single cuts of cable between AES/EBU outputs and inputs. Using several pieces reduces performances. If it is not possible to use single cuts, it is required to use the same model of cable between two AES/EBU interfaces.

In case an amplified controller shuts down, the failsafe relay makes a passive connection between the AES/EBU IN ports and the LINK ports to maintain continuity. However the signals are no longer refreshed for the next amplified controller, so that the input cable and the link cable must be considered as a unique input cable with regard to the maximum supported length.

In case of transmission losses, try to reduce the sampling frequency of the digital audio source. Moreover, as a general rule, avoid using sources rated beyond 96 kHz, as the maximum possible cable length is reduced, while the additional information is cancelled by SRC to 96 kHz.

In a daisy-chain layout, the male XLR link connectors LINK A&B and LINK C&D feed the input signals to the next amplified controller in the signal chain.

Daisy-chaining digital audio

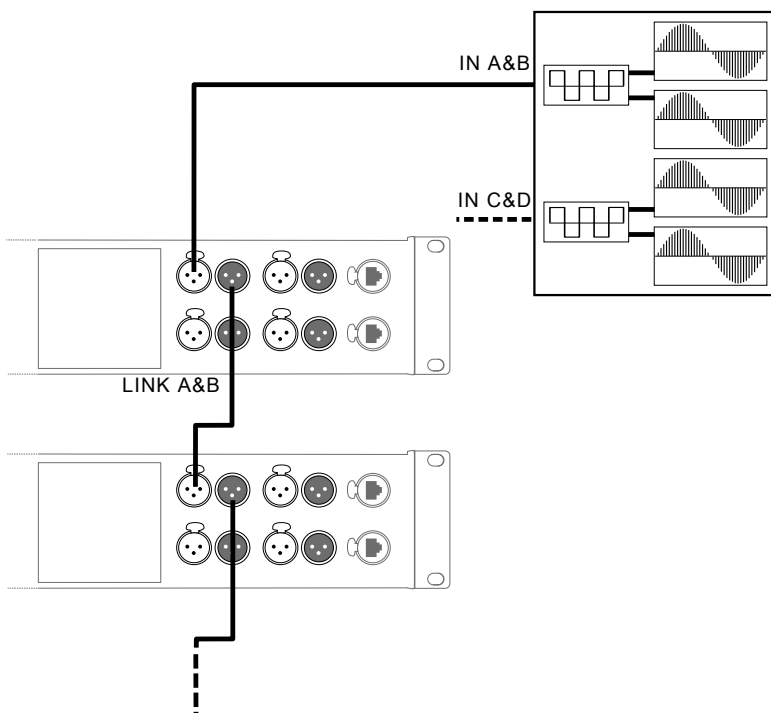

L-NET

! Do not create loops in the network setup

i LA4X and LA12X amplified controllers should always be placed before LA4 and LA8 amplified controllers in daisy-chain networks.

LA4 and LA8 amplified controllers are equipped with former generation 100 Mb/s Ethernet ports that cannot communicate with Ethernet ports of different capabilities, creating detection issues in LA Network Manager.

To connect LA12X to L-NET in a daisy-chain, star or hybrid topology, use the etherCON connectors on the L-NET panel.

Refer to the **LA Network Manager** video tutorial for network setup.

Speaker

To connect an enclosure to the amplified controller, use the speakON or the CA-COM connectors.

Connecting 2-way active enclosures

2-way active enclosure on speakON output - SP

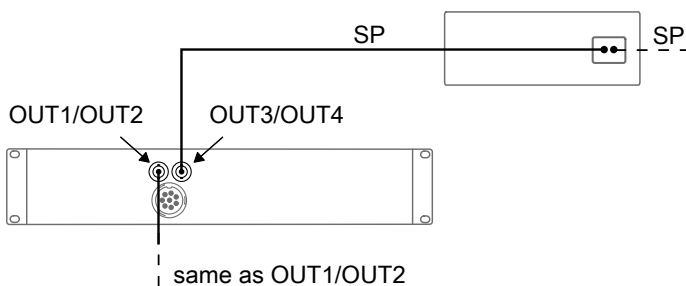

2-way active enclosure on CA-COM output - DO + DOFILL-LA8

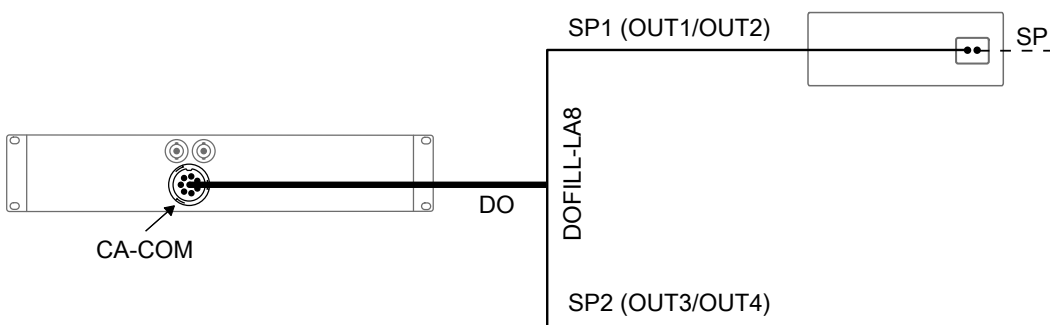

Connecting a 2-way active enclosure with subwoofers

2-way active enclosure and subwoofers on CA-COM output - DO + DO3WFILL

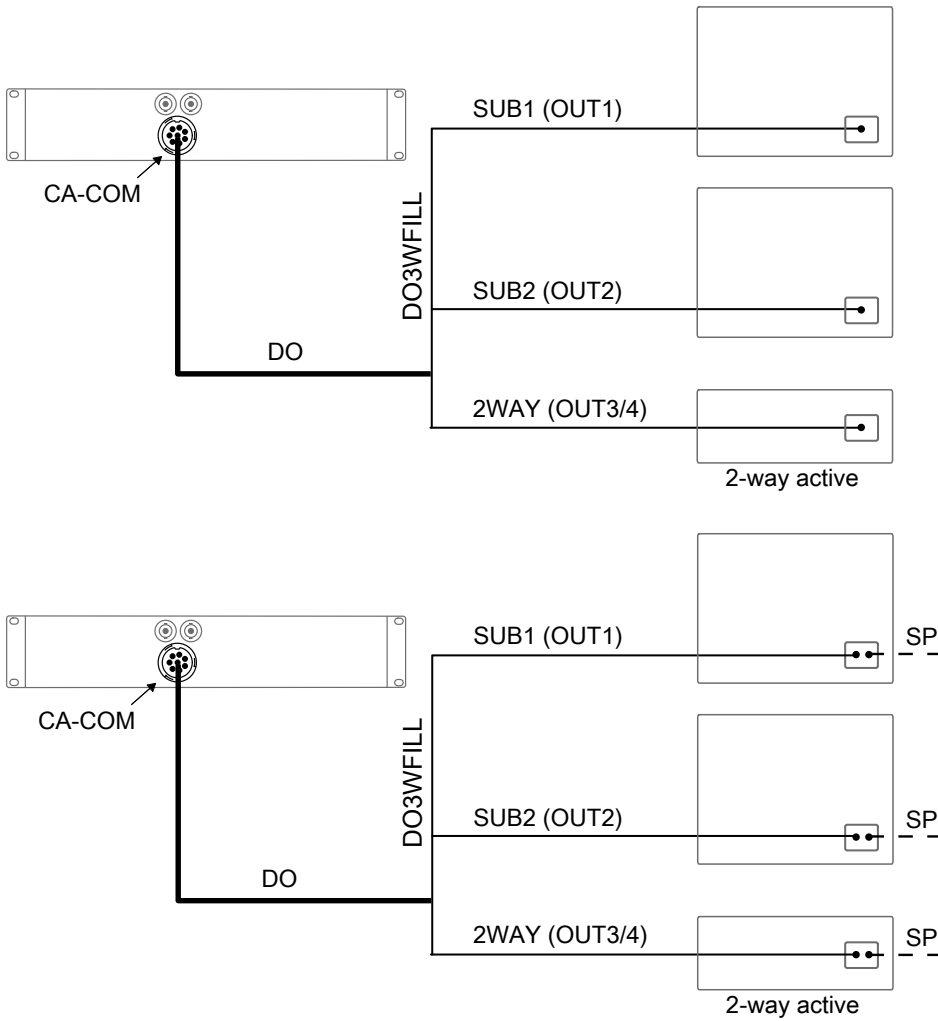

Connecting 2-way passive enclosures

2-way passive enclosure on speakON output - SP + SP-Y1

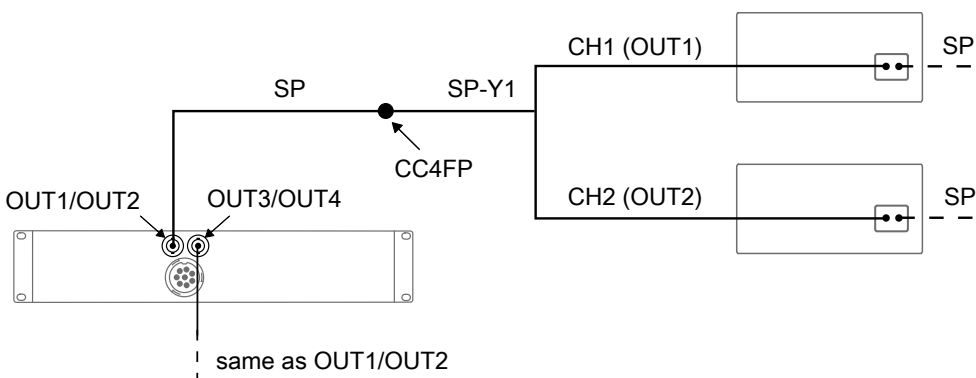

2-way passive enclosure on CA-COM output - DO + DOSUB-LA8

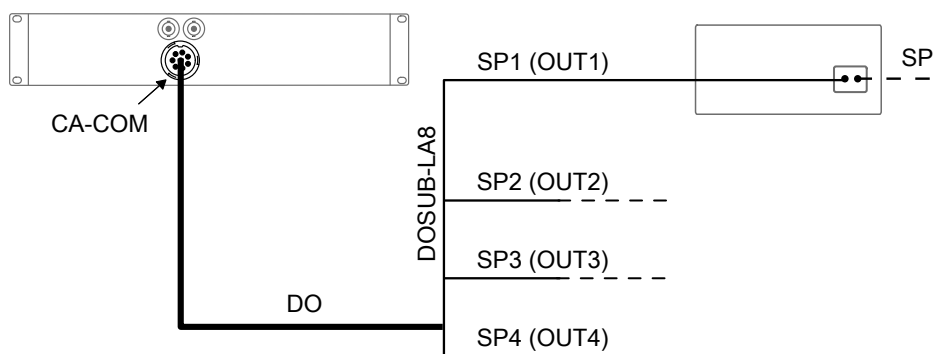

Connecting 3-way active enclosures

3-way active enclosure on CA-COM output - DO

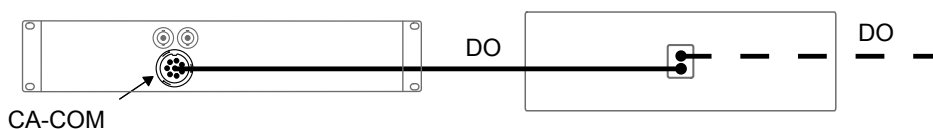

Connecting subwoofers

! Cardioid configuration

Connect the reversed subwoofer(s) to OUT 1 to use the cardioid preset.

Subwoofer on speakON output - SP + SP-Y1

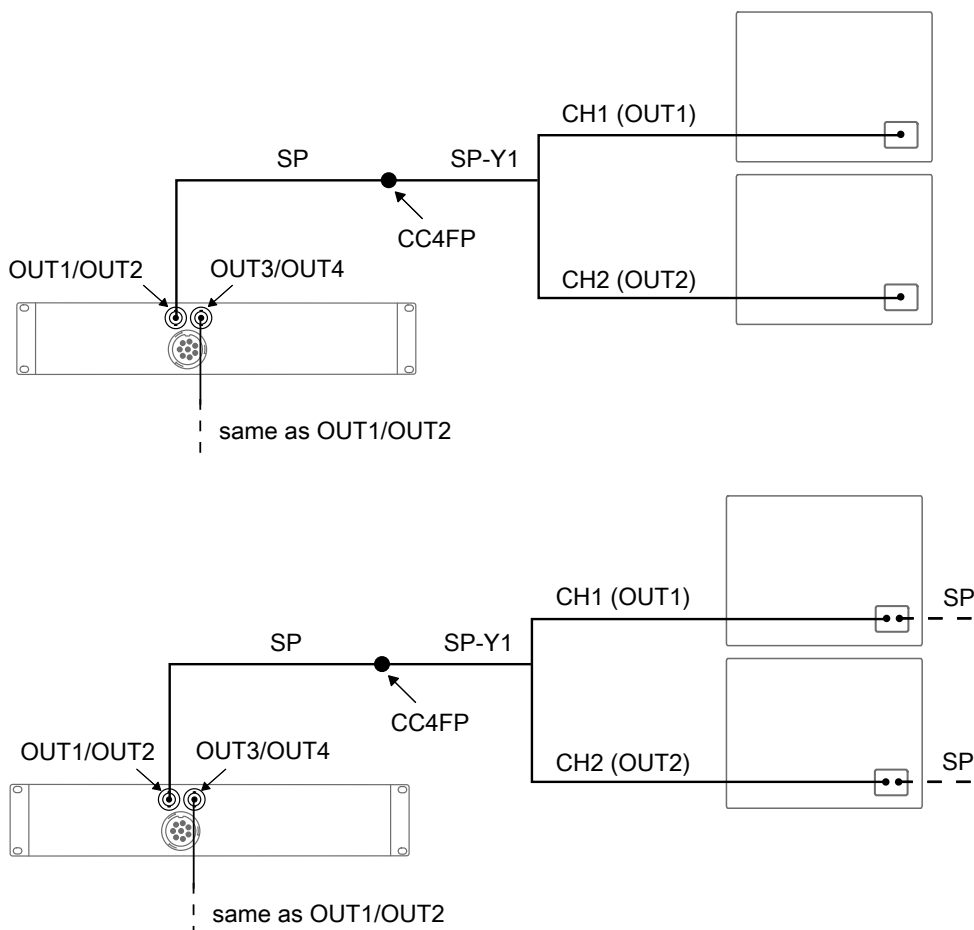

Subwoofer on CA-COM output - DO + DOSUB-LA8

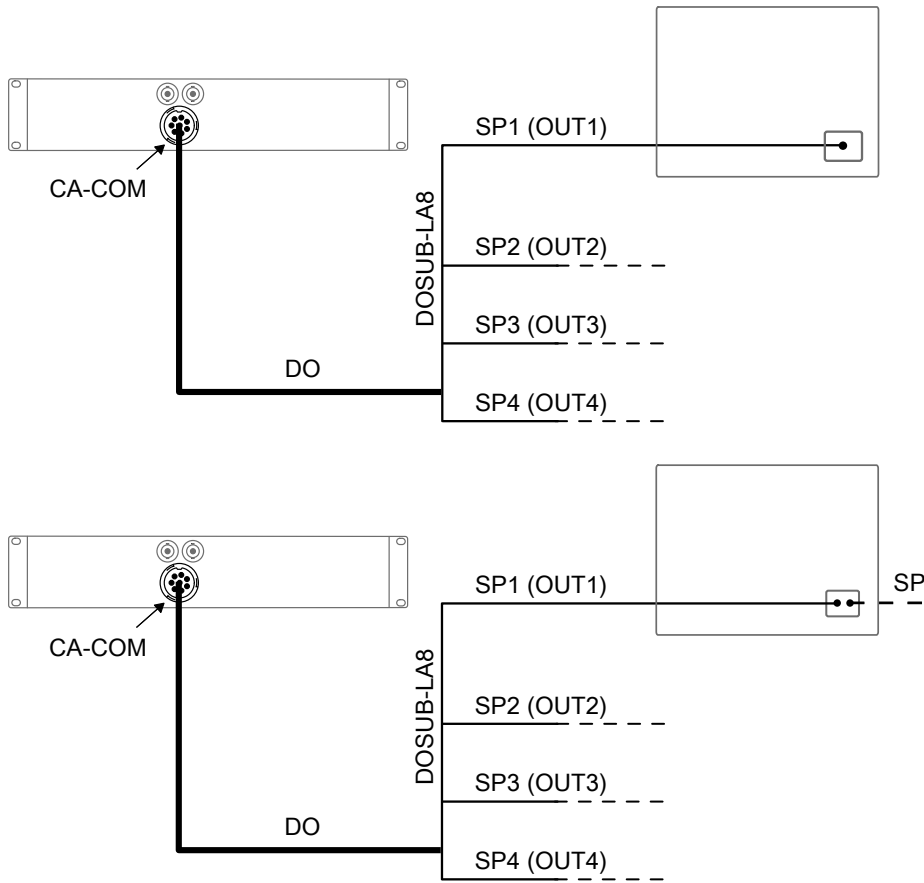

Enclosure drive capacity per LA12X

Maximum number of coaxial enclosures per LA12X

Loudspeaker enclosure	Maximum number of connections per output*	Maximum number of enclosures per controller
5XT	6	24
X8	3	12
X12	3	12
X15 HiQ	3	6
8XT	3	12
Active 12XT	3	6
Passive 12XT	3	12
115XT HiQ	3	6

Maximum number of constant curvature WST enclosures per LA12X

Loudspeaker enclosure	Maximum number of connections per output*	Maximum number of enclosures per controller
ARCS Wide / ARCS Focus	3	12
ARCS II	3	6

Maximum number of variable curvature WST enclosures per LA12X

Loudspeaker enclosure	Maximum number of connections per output*	Maximum number of enclosures per controller
Kiva	3	12
Kara	3	6
K2	3	3
K1	2	2
K1-SB	1	4

Maximum number of subwoofer enclosures per LA12X

Loudspeaker enclosure	Maximum number of connections per output*	Maximum number of enclosures per controller
SB15m	3	12
SB18	3	12
SB28	1	4
KS28	1	4

* For passive loudspeakers, the value corresponds to the number of enclosures in parallel on the output. For active loudspeakers, the value corresponds to the number of sections in parallel on the output.

 For 112XT, 115XT, the MTD series, ARCS, dV-DOSC, Kudo, V-DOSC, KILO, SB118, SB218 and dV-SUB, refer to the enclosure drive capacity table for LA8.

Operation

Powering on

Press the POWER key for one second.

The amplified controller goes through a 9 seconds start-up sequence displaying **Initializing Controller**. The POWER LED turns off, then is lit in orange.

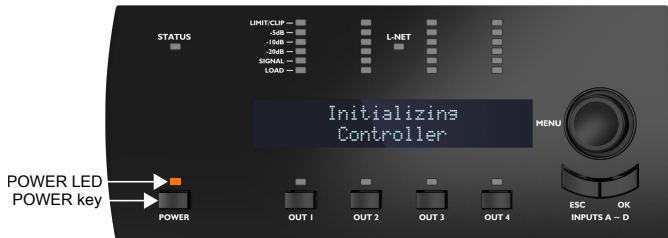

The amplified controller is ready for use when the main screen is displayed and the power LED is lit in green. Refer to section [Main screen description](#) (p.31).

Powering off

Press the POWER key for one second.

The LCD screen and LEDs turn off. The POWER LED is lit in red to indicate that the controller is not disconnected from mains.

The amplified controller is no longer detected over the network, but it still transmits Ethernet data in daisy-chains.

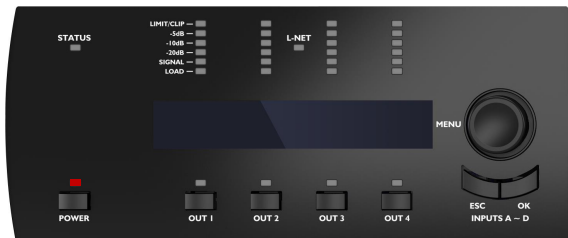

Powering off the amplified controller does not disconnect it from mains.



Power loss

If power is lost, the amplified controller shuts down, but all parameters are restored when the amplified controller switches on again.

Setting to standby mode

To reduce the electrical consumption, the amplified controller can be put in standby mode.

Use LA Network Manager to set the amplified controller to standby or back to operating mode. Refer to the **LA Network Manager** video tutorial.

An amplified controller in standby mode displays **Standby mode** and its POWER LED is lit in orange.

Standby mode can also be cancelled from the amplified controller front panel by pushing and holding the encoder wheel for one second.

Interpreting the front panel LEDs

STATUS

The STATUS LED on the front panel displays the state of the amplified controller.



- green: when the LA12X operates normally
- red: during firmware update or when a fault is detected in the LA12X circuitry, indicating a protection system is active. Refer to [Error messages](#) (p.60)

L-NET

The L-NET LED on the front panel displays the L-NET status.

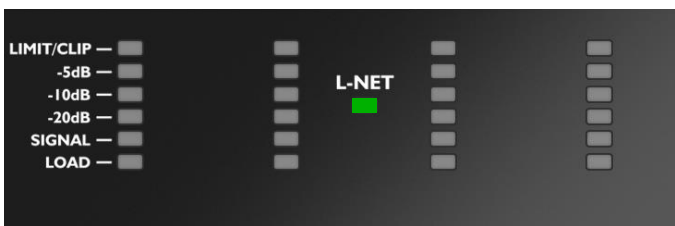

- green: when the LA12X is remotely controlled by software such as LA Network Manager (refer to the **LA Network Manager** video tutorial).
- off: when no software remotely controls the amplified controller.

The front panel commands remain accessible when the L-NET LED is lit.

Meters

The four LED meters (six LEDs each) display the state of the corresponding output channel.

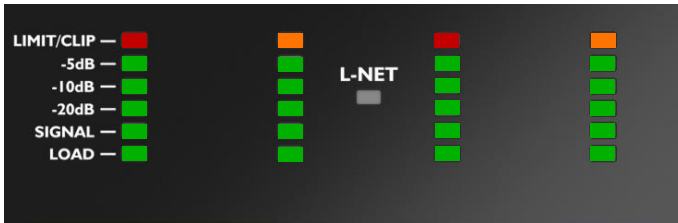

LIMIT/CLIP	orange: the limiter is activated red: the output voltage reaches the maximum level (signal clip)
-5dB	green: the output voltage reaches 5, 10 or 20 dB below the maximum level
-10dB	
-20dB	
SIGNAL	green: a signal is detected and the output voltage reaches 0.1 V
LOAD	green: a load is connected and the output module delivers a minimum of 0.8 A

OUT

The four OUT LEDs on the front panel display the mute status.

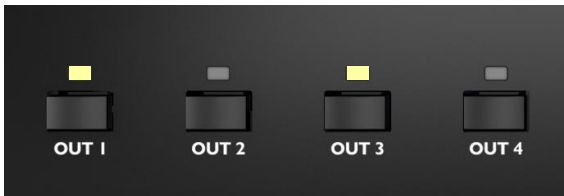

- white: when the corresponding output channel is muted
- off: when the corresponding output channel is unmuted

Main screen description

The amplified controller displays the main screen at the end of the startup sequence.

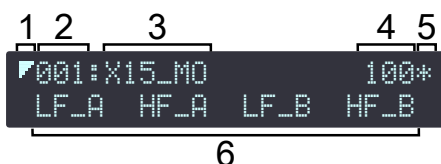

1. **low latency symbol:** indicates loaded preset is a low latency preset (refer to the **LA Network Manager** video tutorial)
2. **preset memory number (001 to 255):** memory space containing the current preset. The preset can be a user preset or come from the on-board preset library — refer to section [LOAD PRESET](#) (p.36)
3. **preset name:** as in the on-board preset library or as entered by the user (if stored in a user preset)
4. **last number of the IP address (1 to 254):** identifies the controller within the L-NET network — refer to section [NETWORK ADDRESS](#) (p.48)
5. **star sign:** indicates unsaved changes in the preset parameters — refer to section [STORE PRESET](#) (p.38)
6. **output name and input selection:** placed above the corresponding output key, written in the **xx_y** form, where:
 - **xx** indicates the type of transducer section or enclosure to be connected to the output channel:
 - LF:** low frequency transducer section, part of a 2 or 3-way loudspeaker enclosure
 - MF:** mid frequency transducer section, part of a 3-way loudspeaker enclosure
 - HF:** high frequency transducer section, part of a 2 or 3-way loudspeaker enclosure
 - PA:** passive loudspeaker enclosure
 - SB:** subwoofer enclosure with the front face towards the audience
 - SR:** subwoofer enclosure with the front face in the opposite direction from the audience (in a cardioid configuration)
 - **y** indicates the input selection of the output channel (input channel or input channels combination selected to drive the output channel) — refer to section [PRESET PARAMETERS](#) (p.39):
 - A:** IN A
 - B:** IN B
 - A+:** sum of IN A and IN B (A+B)
 - A-:** difference between IN A and IN B (A-B)
 - C:** IN C
 - D:** IN D
 - C+:** sum of IN C and IN D (C+D)
 - C-:** difference between IN C and IN D (C-D)
 - X:** sum of IN A, IN B, IN C and IN D (A+B+C+D)

Using quick access functions

Quick access functions are available directly from the main screen. Quick access functions include:

- [Locking/Unlocking the front panel](#) (p.32)
- [Muting/Unmuting an output channel](#) (p.32)
- [Modifying gain](#) (p.33)
- [Identifying an amplified controller](#) (p.33)
- [Displaying input level, input selection, input mode and group information](#) (p.34)

Locking/Unlocking the front panel

The front panel can be locked to prevent unintentional operations.

- To lock: press and hold simultaneously the ESC and OK keys until **Display Locked** is displayed.
- To unlock: press and hold simultaneously the ESC and OK keys until **Display Unlocked** is displayed

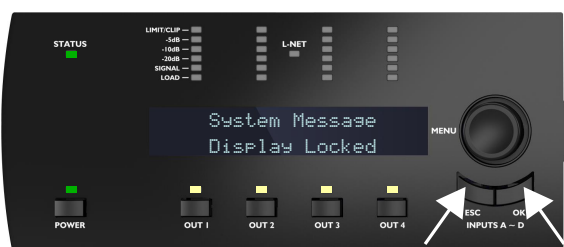

Muting/Unmuting an output channel

By default, all output channels are muted in all factory presets (the OUT LEDs are lit).

- To unmute an output channel: press the corresponding OUT key for less than 0.3 seconds.
- To mute an output channel: press the corresponding OUT key for less than 0.3 seconds.

The screen displays **MUTE OUT** and the mute status of each output channel for 2 seconds.

Example: unmuting OUT1



Gain can be set before unmuting.

Modifying gain

About this task

Gain can be modified for sets of output channels having input channels in common in their input selections.

Examples of output channels having input channels in common:

```

INPUT SELECTION  ↔
  A      B      A+B      A-B
  
```

- The OUT1 key displays gain for OUT1, OUT3 and OUT4 (containing IN A)
- The OUT2 key displays gain for OUT2, OUT3 and OUT4 (containing IN B)
- The OUT3 and OUT4 keys display all channels (containing IN A and/or IN B)

For individual gain settings, refer to section [PRESET PARAMETERS](#) (p.39).

Procedure

1. Press and hold the OUT key of the corresponding output channel.
The screen displays the gain values of all the output channels having an input channel in common.

Example with OUT3 displaying OUT3 and OUT4 (IN B)



2. Turn the encoder wheel to modify the gain values.
Turn the encoder wheel to modify gain by steps of 0.1 dB, or
Press and turn simultaneously the encoder wheel to modify gain by steps of 1 dB.
3. Release the OUT key to return to the main screen.

Identifying an amplified controller

If the amplified controller is connected to the L-NET network, it can be identified among other amplified controllers on the Workspace of LA Network Manager (refer to the **LA Network Manager** video tutorial).

To identify an amplified controller, press and hold the encoder wheel.

On the Workspace of LA Network Manager, the amplified controller blinks in yellow.

On the amplified controller, the L-NET and OUT LEDs flashes and the screen displays **IDENTIFICATION** and the complete IP.

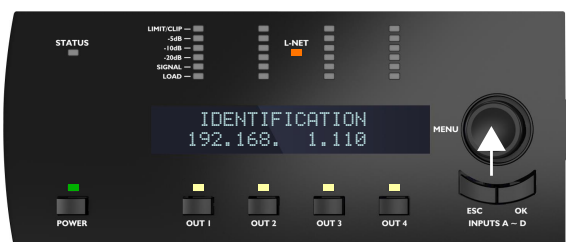

Displaying input level, input selection, input mode and group information

Press and hold the ESC or the OK key to display information about the input level, the input selection, the input mode and the group(s) the amplified controller is assigned to.

- The LED meters and the first line of the screen display information about input channels IN A, IN B, IN C and IN D respectively from left to right:
 - The SIGNAL to LIMIT/CLIP LEDs (1) indicate the level of the signal of the corresponding input channel.



Input voltage values

The SIGNAL LED is lit when the input voltage reaches -38 dBu (analog audio source) or -60 dBfs (digital audio source).

The LIMIT/CLIP LED is lit when the input voltage reaches +22 dBu (analog audio source) or -0.1 dBfs (digital audio source).

Reminder: -38 dBu = 10 mV, 22 dBu = 9.8 V.

- The LOAD LED (2) is lit if the corresponding input channel is part of the input selection of at least one output channel.
- The first line of the LCD screen (3) indicates the input mode and status of input channel pairs AB and CD. Brackets indicate Channel Sets — refer to [PRESET PARAMETERS](#) (p.39).
- The second line of the screen indicates the group names (if any) of output channels OUT1, OUT2, OUT3 and OUT4 respectively from left to right — refer to section [CLEAR GROUP PARAMS](#) (p.41). In case of multiple group assignments, the screen displays **mult_grp**.



For example, in the illustration:



- The signal of channel IN A has a level of -10 dB, the signal of channel IN B has a level of -20 dB and channels IN C and IN D receive no signal (1)
- Channels IN A and IN B are selected and channels IN C and IN D are not selected (2)
- The IN A/IN B pair receives an AES/EBU signal of 44.1 kHz and pair IN C / IN D is configured to receive ANALOG signals. Input mode cannot be different between IN A and IN B or between IN C and IN D (3)
- Channels OUT1 and OUT2 are assigned to the same set of groups, OUT3 is not assigned to any group, and OUT4 is assigned to group **All** (4)

Using the main menu



The main menu gives access to functions and submenus.



i Vertical arrows on the left indicate the current position in the menu:

-  indicates the page is the first in the menu. Turn the encoder wheel clockwise to display the other pages
-  indicates the page is between the first and last in the menu. Turn the encoder wheel clockwise or counterclockwise to display the other pages
-  indicates the page is the last in the menu. Turn the encoder wheel counterclockwise to display the other pages

i Horizontal arrows on the right indicate the availability of submenus:

-  indicates a submenu is available. Press the OK key or the encoder wheel to access it
-  indicates no submenu is available

Procedure

1. From the main screen, press and release the encoder wheel.
2. Turn the encoder wheel to select the page.
A page is selected when it is displayed on the first line of the screen.
3. Press the OK key or the encoder wheel to enter the page.
To return to the main screen, press the ESC key.

Main menu pages

Page	Functionalities	Reference
LOAD PRESET USER	load a user preset (from memories 1 to 10)	LOAD PRESET (p.36)
LOAD PRESET FACTORY	load a factory preset (from memories 11 to 199)	
STORE PRESET	save the current preset (including current settings) as a user preset (in a memory from 1 to 10)	STORE PRESET (p.38)
DELETE PRESET	delete a user preset (in memory from 1 to 10)	DELETE PRESET (p.39)
PRESET PARAMETERS	set parameters for gain, delay, polarity and input selection	PRESET PARAMETERS (p.39)
CLEAR GROUP PARAMS	remove the group parameters defined in LA Network Manager (name, gain, delay, and Contour EQ)	CLEAR GROUP PARAMS (p.41)
INPUT SETTINGS	set the input mode, fallback mode and AES/EBU gain	INPUT SETTINGS (p.42)
MONITORING & INFO	display real-time measured values: RMS output voltage, output temperature (in percentage of the maximum values) and mains voltage (min, max and average) display firmware and preset library versions and amplified controller's MAC address launch ENCLOSURE CHECK	MONITORING & INFO (p.46)
OPTIONS	set the amplified controller's IP address, delay unit, screen contrast reset all parameters to factory settings	OPTIONS (p.48)



All parameters can also be selected from LA Network Manager. Refer to the **LA Network Manager** video tutorial.

LOAD PRESET

A preset can be loaded from two pages:

Page	Memory range	Contents
LOAD PRESET USER	1 to 10 (read and write)	User presets stored by user — refer to STORE PRESET (p.38)
LOAD PRESET FACTORY	11 to 199 (read only)	Factory preset library created by L-Acoustics and automatically installed during firmware update (refer to the LA Network Manager video tutorial)

Example with a factory preset

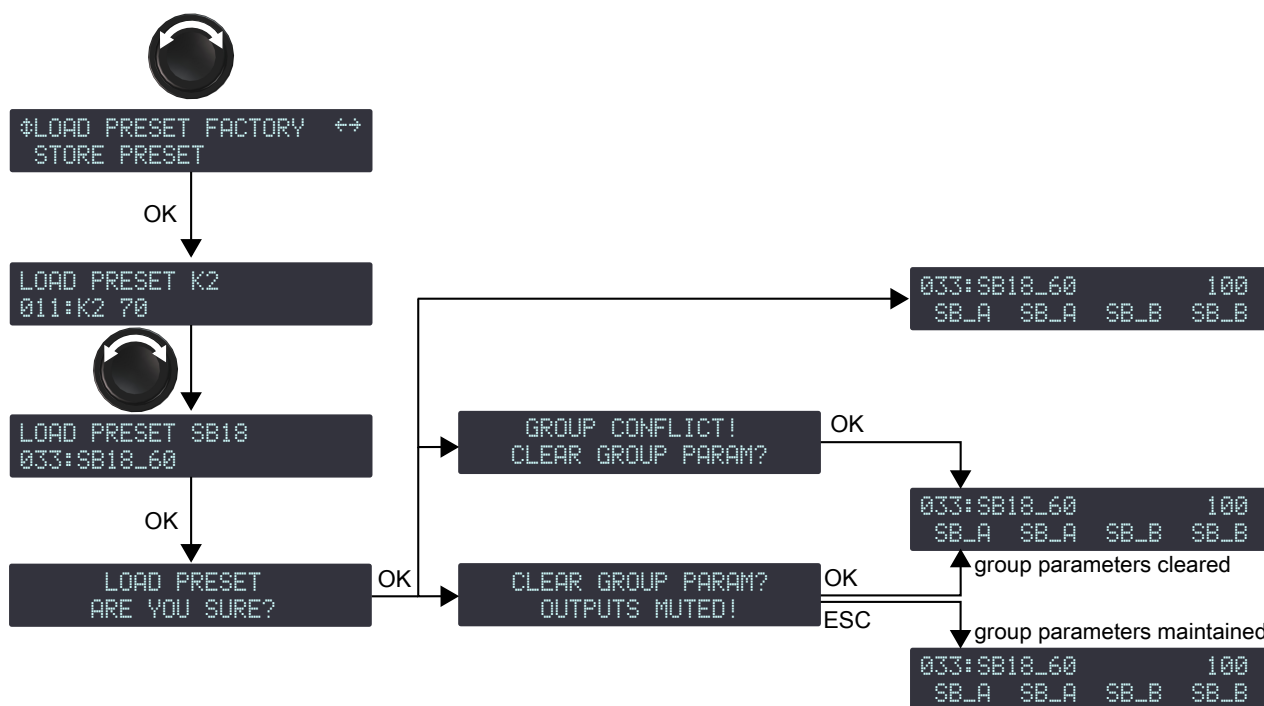

Procedure

1. From the main menu, select **LOAD PRESET USER** or **LOAD PRESET FACTORY**.

i When selecting **LOAD PRESET USER**, the amplified controller displays **NO PRESETS AVAILABLE!** when all user memories are empty.
Press the ESC key to cancel.

2. Turn the encoder wheel and select the preset.
The first line displays **LOAD PRESET** and the preset family name to help make a coarse selection.
The second line displays the preset name to select within a family.

i If a user preset has a customized name, press and hold the encoder wheel to display the original name — refer to section [STORE PRESET](#) (p.38).

3. Press the OK key to load the selected preset.
The amplified controller displays **ARE YOU SURE?**
4. Press the OK key or the encoder wheel to validate (or press the ESC key to cancel).
 - The amplified controller displays **CLEAR GROUP PARAM? OUTPUTS MUTED!** when it is assigned to groups and is no longer connected to the L-NET network.
 - Either** press the OK key to load the preset while clearing the group parameters
 - Or** press the ESC key to load the preset while maintaining the group parameters
 - The amplified controller displays **GROUP CONFLICT! CLEAR GROUP PARAM?** when it is assigned to groups and there is a group conflict. Loading the preset is only possible while clearing the group parameters.
 - Either** press the OK key to load the preset while clearing group parameters
 - Or** press the ESC key twice to cancel
 - The amplified controller displays **GROUP CONFLICT! CANNOT LOAD PRESET!** when it is assigned to groups and there is a group conflict, but it is not possible to clear the group parameters as the amplified controller is connected to the L-NET network.
Press the ESC key twice to cancel.



Possible group conflicts:

The output channels are assigned to groups and the assignment structure is not compatible with the channel sets of the preset to be loaded.

Group parameters include enabled FIR filters (Zoom Factor, FIR1, FIR2, FIR3 or Air Absorption Compensation) and the preset to be loaded is a low latency preset.

STORE PRESET

The currently loaded preset, including all modified settings, can be stored to a user memory (in memory location 1 to 10).



Unsaved modifications to the preset parameters are indicated by a star sign at the end of the first line.

Unsaved modifications are lost if the preset is reloaded prior to storing.

However, the current state of a loaded preset is saved when the amplified controller is turned off.

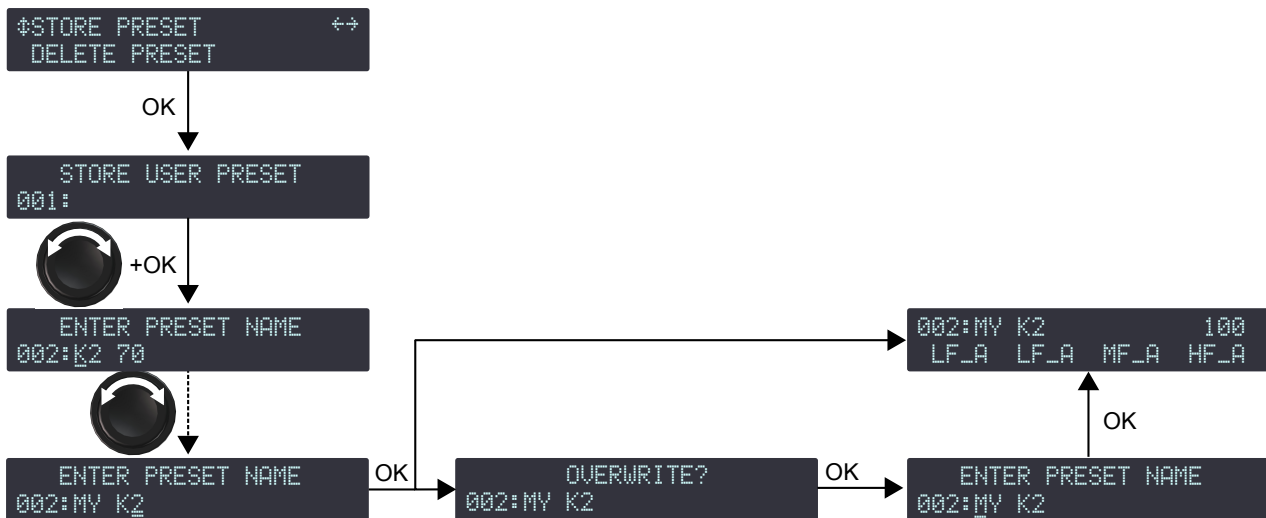

Procedure

1. From the main menu, select **STORE PRESET**.
2. Turn the encoder wheel and select the user memory space.
3. Press the OK key or the encoder wheel to validate.
4. If necessary, enter a user preset name (16 characters max):
 - a) Turn the encoder wheel to select the first character.
 - b) Press the encoder wheel to set the cursor on the second character.
 - c) Repeat until all characters are entered.



Pressing the encoder wheel after the 16th character sets the cursor back to the first character.

5. Press the OK key to validate the name.



The controller displays **OVERWRITE?**, when the selected memory space is not empty.

Press the OK key to overwrite (or the ESC key to cancel).

DELETE PRESET

A user preset stored in a user memory (in memory range 1 to 10) can be deleted.

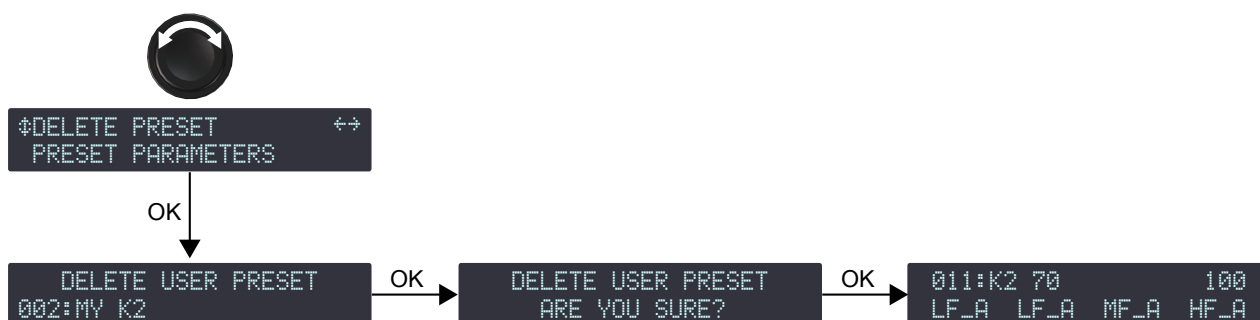

Procedure

1. From the main menu, select **DELETE PRESET**.

i The amplified controller displays **NO PRESETS AVAILABLE!** when all user memories are empty. Press the ESC key to cancel.

2. Turn the encoder wheel to select the user memory space.
3. Press the OK key or the encoder wheel to validate.

i The amplified controller displays **CANNOT DELETE THE CURRENT PRESET**, when the selected preset is the currently loaded preset. It is not possible to delete the currently loaded preset. Press the ESC key to cancel.

The amplified controller displays **ARE YOU SURE?**

4. Press the OK key or the encoder wheel to validate (or press the ESC key to cancel).

PRESET PARAMETERS

The preset parameters include gain, delay, polarity and input selection.



i **Gain and delay value ranges**
Gain is adjustable from -60 dB to +15 dB.

Delay is adjustable from 0 to 1000 ms — see also section [DELAY UNIT](#) (p.49).

i **Total delay**
The total delay includes all group delays (set in LA Network Manager) and the output channel delay. Total delay cannot exceed 1000 ms.

The parameters of the currently loaded preset can be set individually for each output channel or channel set.

i Channel set

In certain presets, some channels are interdependent and form a channel set.

Within a channel set the preset parameters are common to all channels.

On the amplified controller's screen, channel sets are indicated by brackets above the corresponding output channel keys.



Two 2-channel sets (LF/HF - LF/HF)



One 4-channel sets (LF/LF/MF/HF)

Setting the preset parameters

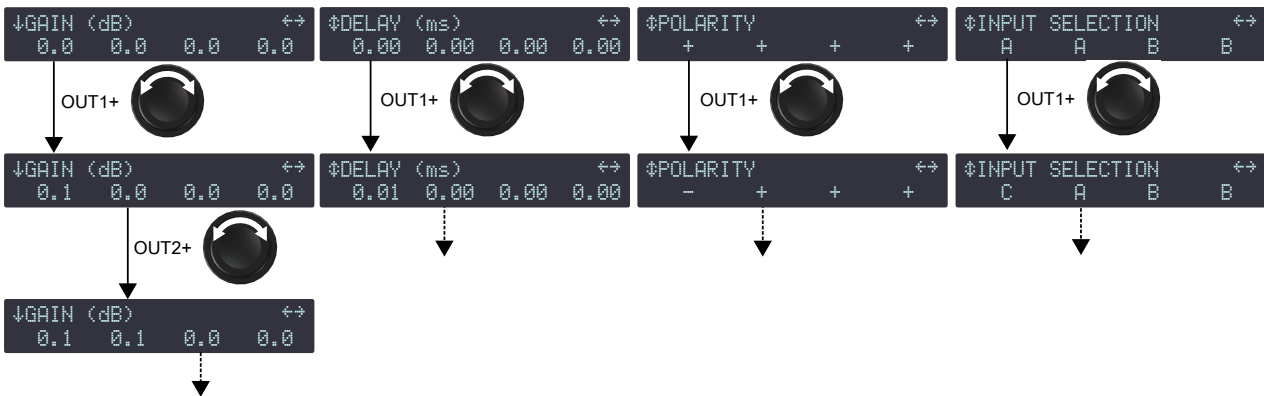

Procedure

1. From the main menu, select **PRESET PARAMETERS**.
2. Turn the encoder wheel to select a preset parameter (**GAIN (dB)**, **DELAY (ms)**, **POLARITY** or **INPUT SELECTION**).
3. Press and hold the output key of an output channel or one of the output keys of a channel set to select it.
4. Turn the encoder wheel to select the value.

i Gain and delay value setting

Turn the encoder wheel for fine resolution (last digit).

Press and turn the encoder wheel for coarse resolution (second to last digit).

5. Release the output key.
6. Repeat steps 3 to 5 for each output channel or channel set.
7. Repeat steps 2 to 5 for each preset parameters.

Preset parameter modifications apply immediately.

i Saving preset parameters

Preset parameter modifications are not automatically saved and are lost if the preset is reloaded.

Refer to [STORE PRESET](#) (p.38).

Resetting the preset parameters

All preset parameters (including preset name) can be reset to the default values.

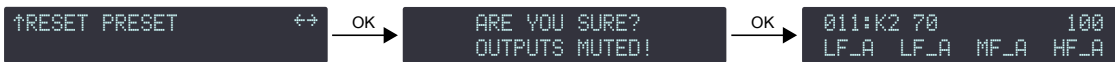

Procedure

1. From the main menu, select **PRESET PARAMETERS**.
2. Turn the encoder wheel to select **RESET PRESET**.
3. Press the OK key or the encoder wheel to validate.
The amplified controller displays **ARE YOU SURE? OUTPUTS MUTED!**.
4. Press the OK key or the encoder wheel to validate (or the ESC key to cancel).



Resetting the parameters of a user preset (stored in memory space 001 to 010) only affects the current parameters.

To reset the parameters of a stored preset, overwrite the memory space after resetting the preset. Refer to [STORE PRESET](#) (p.38).

CLEAR GROUP PARAMS

Group parameters (names, gains, delays, contour EQs) are defined in LA Network Manager and cannot be accessed from the amplified controller. They remain active when the amplified controller is disconnected from the computer running LA Network Manager (in standalone mode), and when the amplified controller is shut down or restarted. Group parameters are not preset-dependent and remain active when a different preset is loaded.

Therefore, L-Acoustics recommends to clear group parameters when an amplified controller is used in standalone mode after being used within a network.

To verify if output channels are assigned to a group, refer to [Displaying input level, input selection, input mode and group information](#) (p.34).



CLEAR GROUP PARAMS does not clear the preset parameters. Refer to [PRESET PARAMETERS](#) (p.39)

Clearing the group parameters

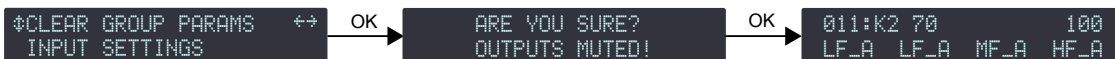

Procedure

1. From the main menu, select **CLEAR GROUP PARAMS**.



The amplified controller displays **L-NET ACTIVE. CANNOT CLEAR** when the amplified controller is connected to the L-NET network. Group parameters cannot be cleared when the amplified controller is remotely controlled by LA Network Manager.

Press the ESC key to cancel.



The amplified controller displays **NO GROUP DEFINED. CANNOT CLEAR** when the amplified controller is not assigned to any group.

Press the ESC key to cancel.

2. Press the OK key or the encoder wheel to validate.
The amplified controller displays **ARE YOU SURE? OUTPUTS MUTED!**.
3. Press the OK key or the encoder wheel to validate (or press the ESC key to cancel).

INPUT SETTINGS

The INPUT SETTINGS menu gives access to settings of the input mode, the fallback mode and the AES/EBU gain.

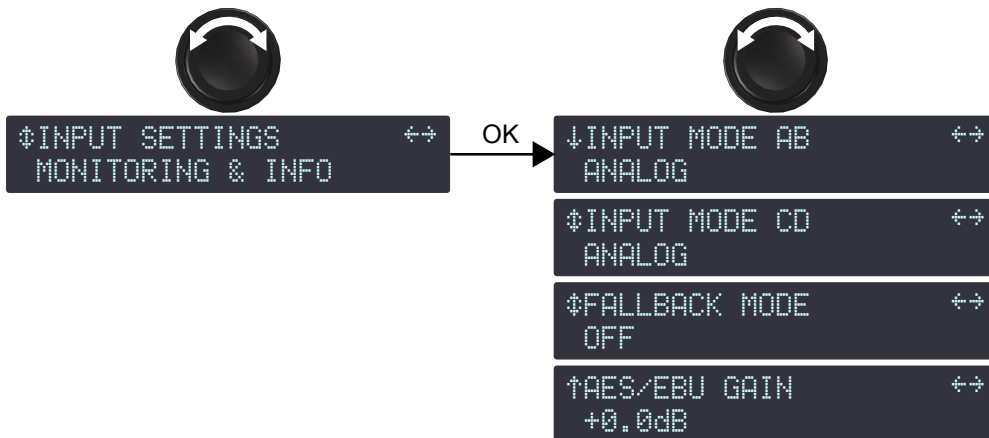

INPUT MODE

The XLR connectors of the signal panel can receive analog or digital signals. Use **INPUT MODE** to select the type of signal, depending on the type of connected audio sources, for channel pairs AB and CD.

The input mode selection can be different between channel pairs AB and channel pairs CD, but it cannot be different between input channel A and input channel B, or between input channel C and input channel D.

Selecting the input mode

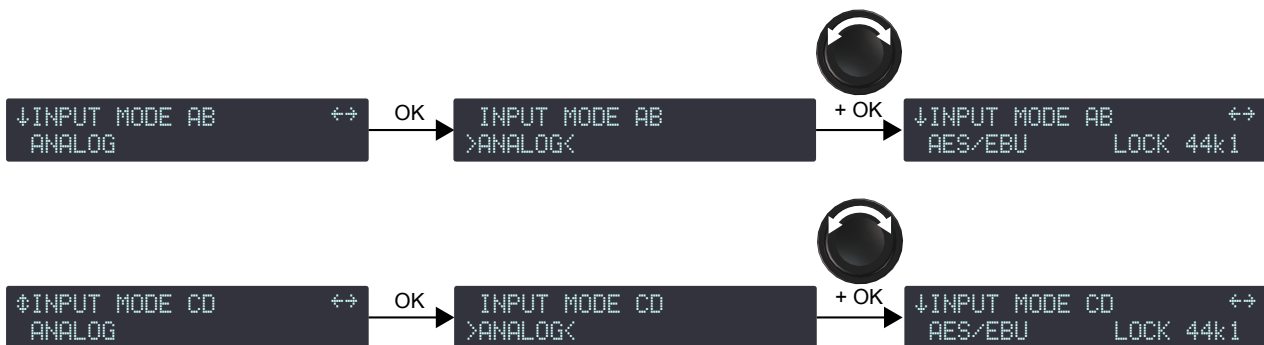

Procedure

1. From the main menu, select **INPUT SETTINGS**.
2. Press the OK key or the encoder wheel to validate.
3. Turn the encoder wheel to select **INPUT MODE AB** or **INPUT MODE CD**.
4. Press the OK key or the encoder wheel to validate.
5. Turn the encoder wheel to select between the input modes (**ANALOG** for analog audio source, **AES/EBU** for digital audio source).
6. Press the OK key or the encoder wheel to validate.
7. Repeat steps 3 to 6 for the other channel pair.

AES/EBU signal statuses

When AES/EBU is enabled, the status of the signals is displayed:

LOCK and the sampling frequency indicates a digital audio source is connected to the AES/EBU input, the signal delivered by the source has a format supported by the controller's digital audio board, and no loss or fault is being detected during data transfer.

For example, LOCK 44k1 indicates the digital audio source provides signals of sampling frequency of 44.1 kHz.

LOCK-WARN indicates the incoming digital signal has a sampling frequency that is out of the nominal range, but it does not lead to sound cut.

UNLOCK indicates the incoming digital signal is faulty and leads to sound cut.

If the fallback mode is active, UNLOCK on channel pair AB automatically switches to channel pair CD. FALLBACK(CD) and the status of the signal on channel pair AB is displayed. Refer to section [FALLBACK MODE](#) (p.44).

The LOCK status is re-acquired after at least 500 ms of stability.

INVALID indicates non-audio data in the payload or errors in the AES/EBU transmission.

```

↓INPUT MODE AB      ↔
AES/EBU      LOCK 44k1

↓INPUT MODE AB      ↔
AES/EBU      LOCK-WARN

↓INPUT MODE AB      ↔
AES/EBU      UNLOCK

↓INPUT MODE AB      ↔
AES/EBU      INVALID

```

```

↓INPUT MODE AB      ↔
FALLBACK(CD) LOCK 44k1

↓INPUT MODE AB      ↔
FALLBACK(CD) LOCK-WARN

↓INPUT MODE AB      ↔
FALLBACK(CD) UNLOCK

↓INPUT MODE AB      ↔
FALLBACK(CD) INVALID

```

Reverting from fallback

When the LOCK status is recovered on channel pair AB, reverting to the initial input mode is manual.

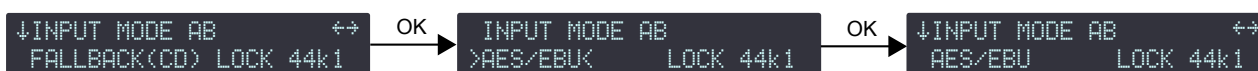

Procedure

1. From the **INPUT MODE AB** menu, press the OK key.
2. Turn the encoder wheel to select the input mode.
3. Press the OK key or the encoder wheel to validate.

FALLBACK MODE

Sound cuts in case of digital signal failure on input pair AB can be avoided with the fallback option.

When automatic fallback is enabled (ON), the amplified controller automatically switches to input pair CD in case of digital signal failure on input pair AB.



Switchover conditions

No clock, loss of lock, CRC error, bipolar encoding error or data slip triggers the automatic fallback.

Validity bit (invalid audio) value does not trigger the automatic fallback. Instead the signal is muted.

Reverting to input pair AB when the digital signal returns to a normal state is manual — refer to [INPUT MODE](#). It can also be done simultaneously for all amplified controllers in LA Network Manager.

When automatic fallback is disabled (OFF), sound is cut off in case of digital signal failure on input pair AB, but sound is automatically recovered when the signal returns to a normal state.

Enabling the fallback mode

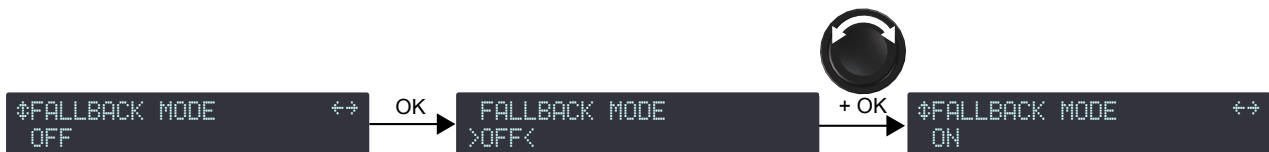

Procedure



Precautions to avoid sound cuts or level differences upon fallback

Input pair CD must be connected to an audio source (analog or digital) playing the same program as the digital audio source connected to input pair AB.

When an analog audio source is connected to input pair CD, the level of the digital audio source connected to input pair AB must be aligned to the level of the analog audio source using AES/EBU GAIN — refer to section [AES/EBU GAIN](#) (p.45).

1. From the main menu, select **INPUT SETTINGS**.
2. Press the OK key or the encoder wheel to validate.
3. Turn the encoder wheel to select **FALLBACK MODE**.
4. Press the OK key or the encoder wheel to validate.
5. Turn the encoder wheel to select the setting (**ON** or **OFF**).
6. Press the OK key or the encoder wheel to validate.

AES/EBU GAIN

AES/EBU GAIN must be used when the fallback mode is enabled, a digital audio source is connected to input pair AB, and an analog audio source is connected to input pair CD, to align the digital audio source level to the analog level for a seamless fallback switch — refer to section [FALLBACK MODE](#) (p.44). AES/EBU gain can be set from -12 dB to +12 dB by steps of 0.1 dB.

The AES/EBU gain must be set according to the analog audio source's calibration (based on manufacturer's specs or user measurements) and the amplified controller's analog inputs calibration (0 dBfs for an input signal of +22 dBu). These examples illustrate the most common cases:

analog audio source calibration	AES/EBU gain
+18 dBu for 0 dBfs	- 4 dB
+24 dBu for 0 dBfs	+ 2 dB
+22 dBu for 0 dBfs or, if fallback is disabled or, if a digital audio source is connected to input pair CD	+ 0 dB



Procedure

1. From the main menu, select **INPUT SETTINGS**.
2. Press the OK key or the encoder wheel to validate.
3. Turn the encoder wheel to select **AES/EBU GAIN**.
4. Press and hold the ESC, OK or OUT1 key.
5. Turn the encoder wheel to select an input value.

Setting applies in real-time.



Turn the encoder wheel for steps of 0.1 dB.
Press and turn the encoder wheel for steps of 1 dB.

6. Release the key.

MONITORING & INFO

The MONITORING & INFO menu provides real-time measurements and information on the amplified controller:

- For each output channel:
 - real-time RMS output voltage (in percentage of the maximum value supported by the connected transducer section)
 - output temperature (in percentage of the operating range)
- minimum, maximum and average voltage of the connected power supply
- version numbers of the amplified controller onboard firmware and preset library
- amplified controller's MAC address
- amplified controller's hardware version
- the ENCLOSURE CHECK function

MONITORING & INFO



SPK HANDLING (%)

SPK HANDLING (%) (speaker handling) displays the RMS voltage measured at each individual amplifier circuit output as a percentage of the maximum voltage supported by the connected speaker section.

In illustration [MONITORING & INFO](#) (p.46), the RMS voltage of channels OUT 1 to OUT 4 is respectively 12, 10, 13, and 11 % of the maximum values.

OUT CH TEMP (%)

OUT CH TEMP (%) (output channel temperature) displays the temperature measured at each individual amplifier circuit output as a percentage of the maximum operating temperature supported by the amplified controller: 90° C / 194° F = 100%.

In illustration [MONITORING & INFO](#) (p.46), the temperature of channels OUT 1 to OUT 4 is respectively 52, 53, 50, and 48 % of the maximum values.

Refer to [Error messages](#) (p.60) for information on the temperature-related messages.

MAINS VOLTAGE (V)

MAINS VOLTAGE (V) displays the minimum (Min), average (Avg) and maximum (Max) voltage of the connected power supply, measured over the past 1.5 seconds, to help visualize if the power supply is undersized or if drops in voltage are occurring.

Ideally, the average value should correspond to the power supply nominal voltage, and minimum and maximum values should not exceed $\pm 10\%$ of the nominal voltage.

In illustration [MONITORING & INFO](#) (p.46), the average is 230 V, minimum is 210 V, and maximum is 255 V.

To reset the measurement, press the OK key.

Refer to [Error messages](#) (p.60) for information on the power supply related messages.

FIRMWARE

FIRMWARE displays the version number of the amplified controller onboard firmware.

Press the encoder wheel to display the fourth digit and the build date (in the YYYYMMDD format).

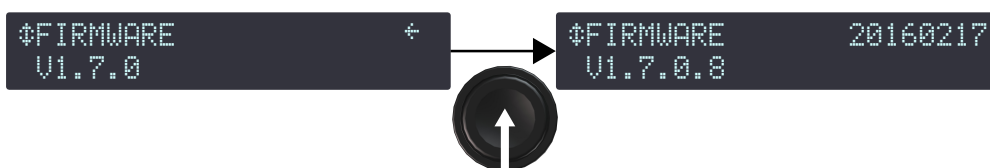

! Network

Always ensure that all LA12X amplified controllers used in a given network run the same firmware version.

PRESET LIBRARY

PRESET LIBRARY displays the version number of the amplified controller onboard preset library.

Press the encoder wheel to display the third digit.

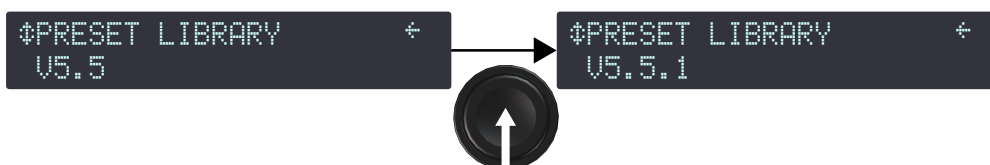

i Refer to the PRESET GUIDE for the full description of the factory preset library.

MAC ADDRESS

MAC ADDRESS displays the MAC (Media Access Control) address of the amplified controller. This address is unique to each amplified controller and is the equivalent of an international identification serial number. It is set by the manufacturer and cannot be modified.

In illustration [MONITORING & INFO](#) (p.46), the MAC address is 00:1B:92:01:90:3A.

HARDWARE INFO

HARDWARE INFO displays the version of the hardware in use in the amplified controller.

For troubleshooting purposes, it can be useful to communicate this number to the L-Acoustics representative.

In illustration [MONITORING & INFO](#) (p.46), the hardware has ID5.

ENCLOSURE CHECK

ENCLOSURE CHECK is a preliminary diagnosis tool for the loudspeaker enclosures connected to the amplified controller.



Refer to the **ENCLOSURE CHECK** technical bulletin for the full procedure.

OPTIONS

The OPTIONS menu gives access to the amplified controller general settings:

- IP address
- delay unit (ms, meters, feet or samples)
- LCD screen contrast
- LED and screen backlight mode
- reset to default factory settings

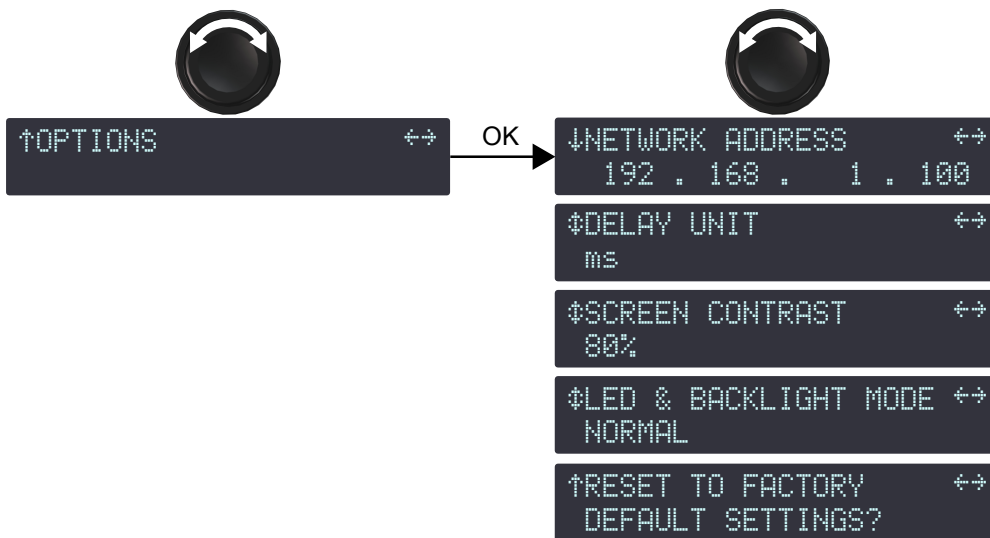

NETWORK ADDRESS

Remote control of amplified controllers requires setting up a private local area Ethernet network to interconnect up to 253 units with a single control computer (and possible additional devices such as Ethernet switches). This Ethernet network is called L-NET and uses a proprietary communication protocol based on TCP/IPv4 called L-COM. The IP addresses on the units are class C addresses and must be set manually. The default subnet for L-NET is 192.168.1.0.



IP address setting

Each unit must be given an IP address that is unique within the local area network.

It is suggested to give the units consecutive IP addresses from 192.168.1.1 to 192.168.1.253, and to set the control computer to 192.168.1.254.



An IP address is a unique identifier for a network device on a given IP network. In IPv4 networking, it is made of 4 bytes. In class C private local area IP subnets, the three first bytes are the network prefix and the last byte is the device identifier on the subnet. Regarding device identifiers, two numbers are reserved: 0 to designate the subnet, and 255 to communicate with all devices of the subnet (the IP broadcast address).

Modifying the IP address



Procedure

1. From the main menu, select **OPTIONS**.
2. Press the OK key or the encoder wheel to validate.
3. Turn the encoder wheel to select **NETWORK ADDRESS**.
4. Turn the encoder wheel to select a value for the last byte (the last number).



Turn the encoder wheel for 1-step resolution.
Press and turn the encoder wheel for 10-step resolution.

5. Press the OK key to validate.



Subnet modification

According to the network administration requirements the default subnet (192.168.1.0) can be modified. Use only Subnet prefixes corresponding to private local area networks according to RFC1918 for LA Network Manager to be able to connect to the amplified controllers. Subnet mask is automatically defined in firmware according to the network class induced by the Subnet prefix (class A, class B, class C).

6. **If needed**, set another byte (first, second or third number) as follows:
 - a) Long-press the OUT key under the byte to select it.
 - b) Turn the encoder wheel to select a value.
 - c) Press the OK key to validate.
 - d) In LA Network Manager:
 1. Click the L-Acoustics logo and select **Options**.
 2. Enter the corresponding values in **IP Range to scan for L-NET**.

DELAY UNIT

Delay values can be displayed in ms (milliseconds), meters, feet or samples. The values in meters and feet are given for a temperature of 20° C / 68° F.



Procedure

1. From the main menu, select **OPTIONS**.
2. Press the OK key or the encoder wheel to validate.
3. Turn the encoder wheel to select **DELAY UNIT**.
4. Press the OK key or the encoder wheel to validate.
5. Turn the encoder wheel to select the value.

SCREEN CONTRAST

The LCD screen contrast can be modified to adapt to a very bright or very dark environment.



Procedure

1. From the main menu, select **OPTIONS**.
2. Press the OK key or the encoder wheel to validate.
3. Turn the encoder wheel to select **SCREEN CONTRAST**.
4. Press the OK key or the encoder wheel to validate.
5. Turn the encoder wheel to select the value.
6. Press the OK key or the encoder wheel to validate.

LED & BACKLIGHT MODE

The brightness of the LED and the LCD screen backlight can be modified to adapt to a very bright or very dark environment.



Procedure

1. From the main menu, select **OPTIONS**.
2. Press the OK key or the encoder wheel to validate.
3. Turn the encoder wheel to select **LED & BACKLIGHT MODE**.
4. Press the OK key or the encoder wheel to validate.
5. Turn the encoder wheel to select the value (**OFF, LOW, MEDIUM, NORMAL** or **SUNLIGHT**).
6. Press the OK key or the encoder wheel to validate.

RESET TO FACTORY DEFAULT SETTINGS?

The amplified controller settings can be reset to the factory default.

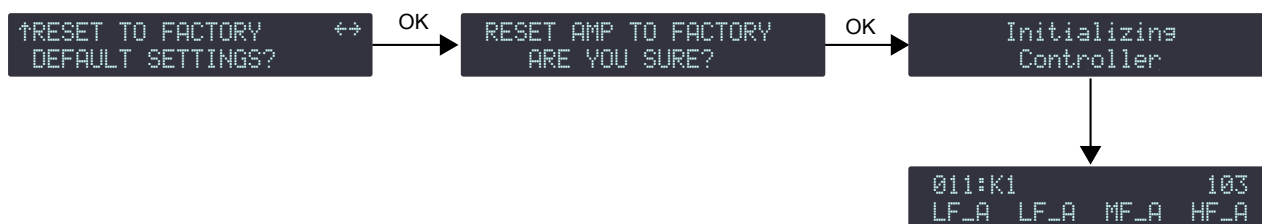

Procedure



Amplified controllers default settings include loading the preset from memory 011. The amplified controller retains its IP address.

1. From the main menu, select **OPTIONS**.
2. Press the OK key or the encoder wheel to validate.
3. Turn the encoder wheel to select **RESET TO FACTORY DEFAULT SETTINGS?**
4. Press the OK key or the encoder wheel to validate.
The amplified controller displays **RESET AMP TO FACTORY, ARE YOU SURE?**
5. Press the OK key or the encoder wheel to validate (or the ESC key to cancel).
The amplified controller launches the start-up sequence. When complete, the amplified controller displays the main screen.

Settings protection

Some settings can be protected from modifications.

Settings protection can only be enabled and disabled from LA Network Manager. Refer to the **LA Network Manager** video tutorial and the **SETTINGS PROTECTION** technical bulletin.

When settings protection is enabled, some settings are completely locked, and the protection on the others can be temporarily bypassed by a 4-digit PIN code.

setting	protection
quick access to gain on OUT1 to OUT4	locked
LOAD PRESET FACTORY	PIN code protected
STORE PRESET	PIN code protected
DELETE PRESET	locked
PRESET PARAMETERS (all parameters)	PIN code protected
CLEAR GROUP PARAMS	PIN code protected
NETWORK ADDRESS	PIN code protected
RESET TO FACTORY DEFAULT SETTINGS?	locked

When settings protection is enabled and a user tries to modify a setting:

locked settings	screen displays ACCESS LOCKED settings cannot be modified press the ESC key to cancel
PIN code protected settings	screen display ENTER PIN enter the PIN code to temporarily bypass the protection or press the ESC key to cancel



Entering a PIN code

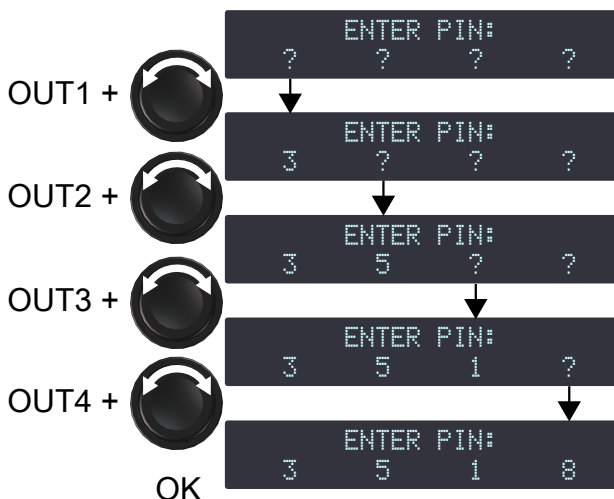

Procedure

1. Press and hold the OUT1 key.
 2. Turn the encoder wheel to select the first digit of the PIN code.
 3. Release the OUT2 key.
 4. Repeat step 1 to 3 with the OUT2, OUT3 and OUT4 key.
 5. Press the OK key or the encoder wheel to validate.
- If the controller returns to the **ENTER PIN** screen, the entered PIN code is wrong.
- Repeat step 1 to 5 with the right PIN code, or press the ESC key to cancel.

Maintenance

This section is intended for end users and gathers the level 1 procedures.



This manual contains the maintenance operations authorized for the end user.

Performing another operation exposes to hazardous situations.

Procedure

1. Perform the [Quality control procedures](#) (p.55) to detect any issue.
2. Refer to the [Troubleshooting / diagnosis](#) (p.57) tables and the [Exploded view](#) (p.68) for indications on how to address these issues.
3. Perform the corrective action [Procedures](#) (p.68).
4. Perform the [Quality control procedures](#) (p.55) again to check that there are no remaining issues.

Equipment and tools

The following table is the complete list of equipment and tools required to perform all level 1 maintenance procedures on the amplified controller.

Name	Reference	Distributor
audio source with a known musical program	—	—
LA Network Manager	—	L-Acoustics
CAT5e U/FTP cable	—	—
full range loudspeaker	—	L-Acoustics
subwoofer	—	L-Acoustics
ear protections	—	—
electric screwdriver with torque selector	-	-
T20 Torx bit	EX.620	FACOM
T30 Torx bit	EX.630	FACOM
3.5 mm flat screwdriver	AN3,5X100	FACOM

Refer to the documentation of the electric screwdriver manufacturer to obtain the setting corresponding to a given torque value. This setting can vary depending on the age of the tool. Verify it on a regular basis.

Quality control procedures

These procedures must be performed for preventive maintenance and to detect possible issues on an amplified controller.

Tools

Name	Reference	Distributor
audio source with a known musical program	—	—
LA Network Manager	—	L-Acoustics
CAT5e U/FTP cable	—	—
full range loudspeaker	—	L-Acoustics
subwoofer	—	L-Acoustics
ear protections	—	—

INSP - External structure

Procedure

Visually inspect the foam filter, grill, Lexan interface, front structure, rear and side brackets, encoder wheel, chassis, connectors, LCD screen and LEDs for obvious damage or lost parts.

CHK - Cleanness

Procedure

1. Disassemble the grill and the foam filter.
Refer to the [Grill and foam filter disassembly procedure](#) (p.70).
 2. Verify if the foam filter is clean.
-  Do not touch any part inside the amplified controller.
3. Look inside the amplified controller through the front grill and verify if the inside is clean.
 4. Reassemble the grill and the foam filter.
Refer to the [Grill and foam filter reassembly procedure](#) (p.70).

CHK - Normal start-up sequence

Procedure

1. Plug the amplified controller to mains.
2. Power the amplified controller on.
3. Verify if the LCD screen and all the LEDs lit during the start-up sequence.

CHK - Network functionalities and firmware

Procedure

1. Connect the controller to an Ethernet port of a computer running LA Network Manager.
Use the CAT5e U/FTP cable.
2. Run LA Network Manager.
3. Verify that the amplified controller is detected as an online Unit (refer to the LA Network Manager video tutorial).
4. Verify that the latest version of the firmware is installed (refer to the LA Network Manager video tutorial).

CHK - Sound presence and quality

Procedure

1. Plug the audio source to an input connector of the amplified controller (IN A, IN B, IN C or IN D).
2. Plug the full range loudspeaker to output connector OUT1 and select a corresponding preset.
3. Select the routing from the audio source to OUT1.
4. Play the musical program.
5. Set the OUT1 gain to -40 dB and unmute OUT1.
6. Set the OUT1 gain to obtain a medium sound level.
7. Verify that the sound is clear and undistorted.
8. Mute OUT1.
9. Repeat step 1 to 8 for OUT2, OUT3 and OUT4.

CHK - Power capability

Procedure



Risk of ear damage due to high sound level

Use ear protections

1. Plug the audio source to an input connector of the amplified controller (IN A, IN B, IN C or IN D).
2. Plug the subwoofer to output connector OUT1 and select a corresponding preset.
3. Select the routing from the audio source to OUT1.
4. Play the musical program.
5. Set the OUT1 gain to -40 dB and unmute OUT1.
6. Set the OUT1 gain to obtain a high sound level.
7. Verify that the sound is clear and undistorted up to the limit level.
8. Mute OUT1.
9. Repeat step 1 to 8 for OUT2, OUT3 and OUT4.

Troubleshooting / diagnosis

For any issue, consider the diagnosis tables for the possible causes and inspection procedures (if any).

Before applying any procedure, consider the *Exploded view* (p.68) to get acquainted with the disassembly/reassembly procedures to perform before and after.

External structure issues

issue	possible cause	diagnosis / procedure
foam filter is clogged	amplified controller is operated in dusty or cracked-oil smoke machine environments	clean or replace the foam filter refer to <i>grill and foam filter</i> (p.70)
foam filter is lost or damaged	mechanical shock	replace the foam filter refer to <i>grill and foam filter</i> (p.70)
inside of the amplified controller is dirty	amplified controller is operated in dusty or cracked-oil smoke machine environments	contact L-Acoustics
grill is lost or damaged	mechanical shock	replace the grill refer to <i>grill and foam filter</i> (p.70)
Lexan interface is lost or damaged	mechanical shock	contact L-Acoustics
front structure is damaged	mechanical shock	contact L-Acoustics
rear brackets are lost or damaged	mechanical shock	replace the rear brackets refer to <i>rear bracket</i> (p.71)
side brackets are lost or damaged	mechanical shock	replace the side brackets refer to <i>side bracket</i> (p.69)
encoder wheel lost or damaged	mechanical shock	contact L-Acoustics
chassis damaged	mechanical shock	contact L-Acoustics
power cord lost or damaged	pulled, trampled, pinched, frayed, etc.	replace the power cord
no power plug is wired to the power cable	country-specific reference does not exist	wire a country-specific plug to the power cable refer to <i>Power cord</i> (p.17).
powerCON connector damaged	mechanical or electrical shock	contact L-Acoustics
speakON connector damaged	mechanical or electrical shock	contact L-Acoustics
CA-COM connector damaged	mechanical shock	contact L-Acoustics
XLR connector damaged	mechanical shock	contact L-Acoustics
etherCON connector damaged	mechanical shock	contact L-Acoustics
LCD screen or LED damaged	mechanical shock	contact L-Acoustics
front handles damaged	mechanical shock	contact L-Acoustics

Interface issues

“black screen”: LCD screen switched off when the controller is on

possible cause	diagnosis / procedure
power cord is not connected to mains	connect the power cord to mains
mains failure or incompatible voltage	check that mains are available and that voltage is compatible with the indications on the identification plate of the amplified controller (on rear panel)
power cord damaged	inspect the power cord. If necessary, replace it
other causes	contact L-Acoustics

"grey screen": LCD screen lit but nothing is displayed

possible cause	diagnosis / procedure
amplified controller is connected to a non-compatible network	unplug all cables from the L-NET connectors and restart the controller
condensing humidity into the LCD screen	put the controller in a non-condensing environment and wait until the LCD screen is dry
other causes	contact L-Acoustics

LCD screen lit but dark

possible cause	diagnosis / procedure
LED & Backlight settings on low or off	modify the LED & Backlight settings
other causes	contact L-Acoustics

any action from the front interface has no effect

(controller not in standby mode and not locked, refer to the LA Network Manager video tutorial)

possible cause	diagnosis / procedure
any	contact L-Acoustics

one LED in a meter does not work (while the other LEDs of this meter works)

possible cause	diagnosis / procedure
any	contact L-Acoustics

the L-NET LED does not work when online

(refer to the LA Network Manager video tutorial)

possible cause	diagnosis / procedure
any	contact L-Acoustics

amplified controller does not power on (power LED does not lit)

possible cause	diagnosis / procedure
power cord not connected to mains	connect the power cord to mains

possible cause	diagnosis / procedure
mains failure	check that mains are available
power cord damaged	inspect the power cord. If necessary, replace it
other causes	contact L-Acoustics

amplified controller does not power on (power LED is always red)

possible cause	diagnosis / procedure
any	contact L-Acoustics

L-NET network issues

impossible to connect a controller to the L-NET network (controller not in "grey screen")

Refer to the LA Network Manager video tutorial for software use.

possible cause	diagnosis / procedure
LA Network Manager is set in offline mode	select the online mode
selected scanning range does not contain the amplified controller IP address	include the amplified controller IP address into the scanning range
amplified controller is set with an incorrect IP address, or several amplified controller are set with the same IP address	set the computer IP address and subnet mask and the amplified controller IP address as indicated in the LA Network Manager video tutorial
L-NET cable is not plugged or incorrectly plugged	plug and secure CAT5e U/FTP cables into the L-NET connectors on the amplified controllers to connect it to the other amplified controllers, the computer or to the Ethernet switch (each of the amplified controller connectors can be equally used as an IN or LINK connector) Refer to the LA Network Manager video tutorial.
L-NET cable is damaged	replace all damaged CAT5e U/FTP cables in the network chain
more than two software clients are already connected to the amplified controller	disconnect all other software clients
firmware failure	restart the amplified controller
other causes	contact L-Acoustics

Error messages

A system message blinks and the STATUS LED is lit in red.



There is a corresponding event message in LA Network Manager (refer to the **LA Network Manager** video tutorial)

Service message

System Message
Unit service required

Displayed every 1.5 seconds in alternance with an issue's specific error message if this issue requires urgent maintenance on the amplified controller. The controller must be sent to an L-Acoustics representative for maintenance.

Mains voltage messages

LA12X is equipped with a universal SMPS (Switched Mode Power Supply) compatible with mains input nominal voltages of 100 V / 240 V $\pm 10\%$. The mains connected to LA12X is monitored for under and over-voltage, refer to section [MAINS VOLTAGE \(V\)](#) (p.47).

System Message
Mains overvolt warning

Displayed if mains voltage reaches a value 11 to 20 % above nominal. The amplified controller remains operational, but mains voltage should be monitored.

System Message
Mains overvolt error

Displayed if mains voltage reaches a value 20 % and more above nominal. The SMPS reboots. The amplified controller should be connected to a more stable mains power supply.

System Message
Mains peak volt warning

Displayed if mains voltage reaches a peak value of 362 V. The amplified controller remains operational, but mains voltage should be monitored.

System Message
Mains peak volt error

Displayed if mains voltage reaches a peak value of 400 V. The SMPS reboots. The amplified controller should be connected to a more stable mains power supply and/or mains power supply should be checked by a qualified electrician, in particular the neutral connection.

System Message
Mains under volt warning

Displayed if mains voltage reaches a value 10 to 20 % below nominal. The amplified controller remains operational, but mains voltage should be monitored.

System Message
Fuseprotect

Displayed if the mains voltage reaches a value 30 % to 20 % below nominal. The outputs are muted. Normal operation resumes when mains voltage returns to nominal state.

System Message
Mains under volt error

Displayed if mains voltage reaches a value of 50 V. The SMPS reboots. The amplified controller should be connected to a more stable mains power supply, the length of power supply cables should be reduced, larger gauge power cables should be used, or less devices in parallel should be connected to this power line.

Mains frequency messages

LA12X is equipped with a universal SMPS (Switched Mode Power Supply) compatible with mains input nominal frequency of 50 Hz / 60 Hz. The mains frequency is monitored for under and over-frequency.

System Message
Mains over freq warning

Displayed if mains frequency reaches a value of 65 Hz or above. The amplified controller remains operational.

System Message
Mains under freq warning

Displayed if mains frequency reaches a value of 44.9 Hz or below. The amplified controller remains operational.

These messages may be displayed when the power supply (typically a generator) is being challenged by the power demand of the connected amplified controllers. Suggestion: slightly reduce the audio levels to reduce the power demand.

Component status messages

LA12X components are monitored for major or critical errors and faults.

System Message Varistor fault	Displayed if the line filter varistor is faulty. Risk of critical damage to the amplified controller at the next peak on power supply.
System Message SMPS com link fault	Displayed if the communication link with the SMPS is faulty. The SMPS cannot report its status or the mains status
System Message SMPS com link offline	Displayed if the communication link with the SMPS is offline. The SMPS cannot report its status or the mains status.
System Message SMPS short-circuit	Displayed if the SMPS has an internal short-circuit. The SMPS initiates a shut down for safety.
System Message SMPS PFC protection	Displayed if the SMPS power factor correction is faulty. The SMPS initiates a shut down for safety.
System Message SMPS controller error	Displayed if the SMPS microcontroller is faulty. The amplified controller cannot operate.
System Message SMPS 3.3V error	Displayed if the SMPS 3.3 V supply is out of range. The amplified controller cannot operate.
System Message SMPS low power 5V error	Displayed if the SMPS low power 5 V supply is out of range. The amplified controller cannot operate.
System Message SMPS high power 5V error	Displayed if the SMPS high power 5 V supply is out of range. The amplified controller cannot operate.
System Message SMPS -15V error	Displayed if the SMPS -15 V supply is out of range. The amplified controller cannot operate.
System Message SMPS +15V error	Displayed if the SMPS +15 V supply is out of range. The amplified controller cannot operate.
System Message SMPS rail voltage error	Displayed if the SMPS rail voltage supply is out of range or asymmetric. The SMPS initiates a fast restart.
Unknown HW revision Contact L-ACOUSTICS	Displayed if the DSP identification cannot be determined.
System Message Hardware error	Displayed if the firmware encounters a non-specified hardware error during startup or operation.
System Message FPGA error	Displayed if the FPGA cannot be initialized. Try to update the firmware. If the issue persists, contact L-Acoustics.
System Error DSP start-up fault	Displayed if the DSP cannot initialize. Try to update the firmware. If the issue persists, contact L-Acoustics.

The controller must be sent to an L-Acoustics representative for maintenance.

Output channel external error messages

The output channels are continuously monitored for external errors.

Short-circuit on ch # Channel muted	Displayed if a short-circuit is detected at an output channel. The channel is muted for 2 seconds. Check the loudspeaker cables and connectors, including link cables.
Under impedance on ch # Channel muted	Displayed if a short-circuit is detected at an output channel. The channel is muted for 2 seconds. Check the loudspeaker cables and connectors, including link cables.

If the error persists after disconnecting all cables and rebooting, the controller must be sent to an L-Acoustics representative for maintenance.

Output channel internal error messages

The output channels are continuously monitored for internal errors.

DC on channel # Channel muted	Displayed if a sporadic DC voltage above 8 V is detected at an output channel. The channel is muted for 0.5 seconds. The channel is automatically unmuted when returning to nominal state.
DC on channel # Channel disabled	Displayed if a DC voltage above 8 V is detected at an output channel for more than 0.5 seconds. The SMPS initiates an emergency shut down for safety. Reboot is required.
15V under volt on ch # Channel muted	Displayed if a voltage below 10 V is detected at an output channel. The channel is muted for 0.5 second.
15V overvoltage on ch # Channel muted	Displayed if a voltage above 18 V is detected at an output channel. The channel is muted for 0.5 second.
Rail under volt on ch # Channel muted	Displayed if rail voltage is below 110 V at an output channel. The channel is muted for 0.5 second.
Rail overvolt on ch # Channel muted	Displayed if rail voltage is above 190 V at an output channel. The channel is muted for 0.5 second.
CC on channel # Channel disabled	Displayed if a cross-conduct in the power stage is detected at an output channel. The SMPS initiates an emergency shut down for safety. Reboot is required.

If the error persists after disconnecting all cables and rebooting, the controller must be sent to an L-Acoustics representative for maintenance.

Network message

System Message Invalid L-NET client	Displayed if the amplified controller detects a connection attempt from a version of LA Network Manager that is not compatible with the unit firmware (typically because the version of LA Network Manager is too old to manage the latest firmware features). Update LA Network Manager to version 2.3.0.0 minimum.
----------------------------------------	----------------------------------------------------------------------------------------------------------------------------------------------------------------------------------------------------------------------------------------------------------------------------------------------------------------------

Other messages

HF error on ch # Channel muted	Displayed if energy above 25 kHz is detected at an output channel. The channel is muted for 2.5 seconds. Make sure the latest preset is being used. Contact your L-Acoustics representative for advice.
System Message Update error	Displayed if the firmware update has failed. Try to restart the amplified controller. If the issue persists, check that each L-NET cable is in working order and is correctly plugged on both ends and relaunch the update process. If the issue persists, contact L-Acoustics.
High temp on ch # Channel attenuated	Displayed if temperature at an output channel is above 90° C. The signal delivered at the output channel is attenuated until temperature returns to nominal conditions.
Over temp on ch # Channel muted	Displayed if temperature at an output channel is above 96° C. The signal delivered at this output channel is muted until the temperature returns to nominal conditions.
System Message Fan blocked	Displayed if a fan is faulty. The controller remains operational but there is a risk of temperature rising.
System Message SMPS high temp warning	Displayed if SMPS temperature reaches 75° C. The controller remains operational but temperature should be monitored.
System Message SMPS over temp error	Displayed if SMPS temperature reaches 80° C and above. The SMPS initiates a fast restart.
System Message SMPS low temp warning	Displayed if SMPS temperature reaches -15° C. The controller remains operational but temperature should be monitored.
System Message SMPS under temp error	Displayed if SMPS temperature reaches -20° C and lower. The SMPS initiates a fast restart.
Module high temp on ch # Channel muted	Displayed if temperature at a power output module reaches 97° C. The channel is muted for 2.5 seconds.
Module over temp on ch # Channel disabled	Displayed if temperature at a power output module reaches 102° C and above. The SMPS initiates an emergency shut down for safety. Reboot is required.

For temperature messages:

possible cause	diagnosis / procedure
room temperature is too high / too low	make sure room temperature is within amplified controller operating condition range (0° C / 32° F to +50° C / 122° F)
foam filter clogged	clean the foam filter
amplified controller is not getting enough cool air	install the amplified controller in an open area so that the front and rear panels are not blocked by an external objects or structure. If rack-mounted: <ul style="list-style-type: none"> — do not block the ventilation grill with front and back panels or doors, or use a forced ventilation system — when stacking more than one amplified controller, mount them directly on top of one another or close the free spaces with blank panels
channel resources are solicited to their limits	monitor the channel LED meter: in case of persistent high level or clip, reduce the audio source output level (refer to the third-party documentations) or the gain value on the channel.
loudspeaker impedance too low	check that nothing causes a short-circuit at the output (incorrect cabling scheme, damaged cable or short-circuit in the speaker voice coil).

Sound issues

no sound with no error message

(amplified controller is not in standby mode. Refer to the LA Network Manager video tutorial)

possible cause	diagnosis / procedure
mains failure	inspect the mains
outputs are muted	unmute the outputs
incorrect input mode	if the fallback mode is ON, switch it OFF. Select the input mode according to the audio source format (analog or AES/EBU)
incorrect preset selection	select a preset in accordance with the loudspeaker system connected to the outputs
gain value is too low on the amplified controller	set an appropriate gain value on channels OUT1 to OUT4. If the AES/EBU input mode is selected, set an appropriate AES/EBU input gain value.
audio source is not plugged, incorrectly plugged, or plugged into the wrong input connector	(re)plug and secure each XLR cable into the audio source and the corresponding input connector on the amplified controller (analog input connector for analog audio source, AES/EBU input connector for AES/EBU audio source)
audio source cable is damaged	replace the XLR cable
incorrect settings on the audio source	set appropriate parameter values on the audio source, in particular the output gain value (refer to the third-party documentation)
non-audible bit stream	check that the AES/EBU source does not deliver non-audio bit stream (e.g. encoded audio)
audio source failure	inspect the audio source for failure Reminder: A digital audio source can meet the following failures: no clock, loss of lock, invalid audio (validity bit), CRC error, bipolar encoding error, data slip.
loudspeaker not plugged, incorrectly plugged, or plugged into the wrong output connector	(re)plug and secure each speakON cable into the loudspeaker and the corresponding output connector on the amplified controller
loudspeaker cable is damaged	replace the loudspeaker cable
loudspeaker is damaged	if only one loudspeaker is connected, inspect it
other causes	contact L-Acoustics

noise, level loss, distorted sound, white noise (no error message)

possible cause	diagnosis / procedure
AES/EBU audio source is connected to an analog input	check the input signal cabling and check that the input mode has been selected accordingly in the INPUT SETTINGS menu
gain value too high on the amplified controller	set an appropriate gain value on channels OUT1 to OUT4. If the AES/EBU input mode is selected, set an appropriate AES/EBU input gain value.
output gain value too high on the audio source	set an appropriate output gain value on the audio source (refer to the third-party documentation)
switch to the analog fallback mode with incorrect AES/EBU input gain value	set an appropriate AES/EBU input gain value and inspect the digital audio source for failure. Reminder: A digital audio source can meet the following failures: no clock, loss of lock, invalid audio (validity bit), CRC error, bipolar encoding error, data slip.
incorrect preset selection	select a preset in accordance with the loudspeaker system connected to the outputs
audio source cable incorrectly plugged	unplug the XLR cable and plug it again on the audio source and the amplified controller. Verify with your installer if ground loops can occur.
audio source cable damaged	replace the XLR cable
incorrect settings on the audio source	set appropriate parameter values on the audio source (refer to the third-party documentation).
audio source failure	inspect the audio source for failure
loudspeaker incorrectly plugged or plugged into the wrong output connector	(re)plug and secure each speakON cable into the loudspeaker and the corresponding output connector on the amplified controller Verify with your installer if ground loops can occur.
loudspeaker cable damaged	replace the speakON cable
loudspeaker is damaged	if only one loudspeaker is connected, inspect it
other causes	contact L-Acoustics

sound only available in one input mode and not the other

sound only available in AES/EBU and not in analog, or sound only available in analog and not in AES/EBU

possible cause	diagnosis / procedure
any	contact L-Acoustics

Repair kits

KR LABRACKET

Kit rear brackets for LA4/LA4X/LA8

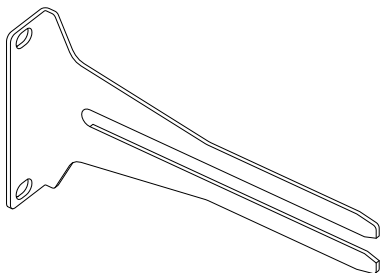

MC LA4XEQAR

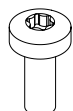

CV TCB616I



CV ROTCB

code	description	qty
MC LA4XEQAR	LA4, LA4X, LA8 and LA12X rear bracket	2
CV TCB616I	M6x16 pan head screw	4
CV ROTCB	nylon washer Ø6 mm	4

KR LA4XGRI

LA4X grills



MC LA4XGRL



CT LOGO3

code	description	qty
MC LA4XGRL	LA4X and LA12X grill	1
CM LA4X	LA4X and LA12X foam filter (not represented)	1
CT LOGO3	17x17 logo	1

KR LA4XMOU

LA4X 10 dust foams

code	description	qty
CM LA4X	LA4X and LA12X foam filter (not represented)	10

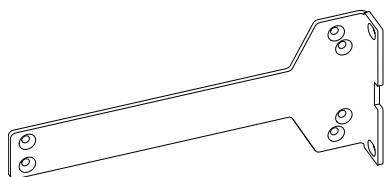
G03285

17721

code	description	qty
17721	LA12X side bracket	1

G03286DIN14585
M2.9X9.5

DIN7991 M4X10

DIN912
M4X6ISO14581
M3X6

DIN7985 M3X6

ISO14581
M4X8

ISO14583 M3X12

ISO14581
M3X10

WN5452-25X8



CHA162RESUP1

code	description	qty
DIN14585 M29X95	M2.9x9.5 Torx black screw	11
DIN7991 M4X10	M4x10 countersunk head silver screw	1
DIN912 M4X6	M4x6 cylinder head silver screw	1
ISO14581 M3X6	M3x6 Torx countersunk head black screw	6
DIN7985 M3X6	M3x6 Phillips back-head tothing black screw	7
ISO14581 M4X8	M4x8 Torx black screw	6
ISO14583 M3X12	M3x12 Torx back-head tothing black screw	4
ISO14581 M3X10	M3x10 Torx countersunk head black screw	2
WN5452-25X8	M2.5x8 Torx black screw	16
CHA162RESUP1	rear bracket support disk for LA4 / LA8 / LA4X / LA12X	1

Procedures

Exploded view



* The fasteners are provided in G03286.

External modules of the amplified controller

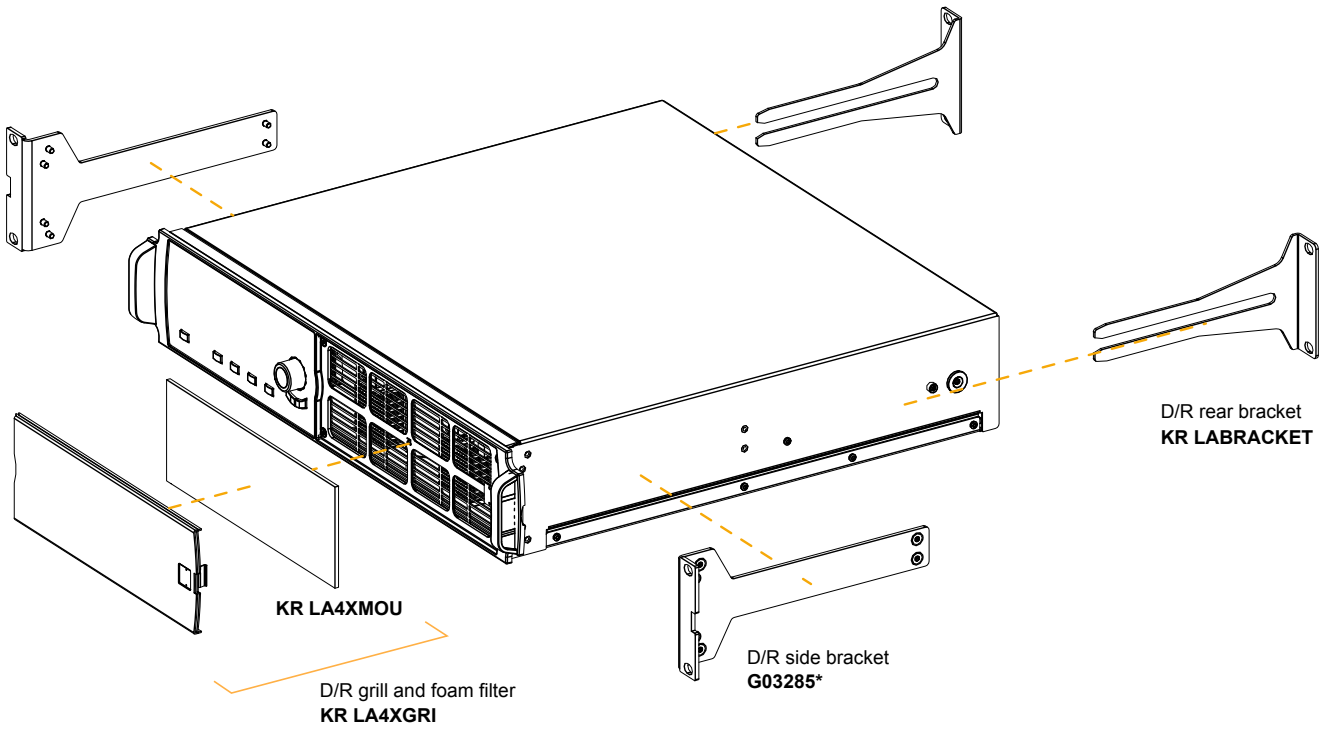

D/R - side bracket

This procedure describes how to replace a side bracket of an LA12X amplified controller.

Tools

Name	Reference	Distributor
electric screwdriver with torque selector	-	-
T20 Torx bit	EX.620	FACOM

Repair kits

Name	Designation	Qty
G03285	LA12X side bracket	1
G03286	LA12X external fasteners	1

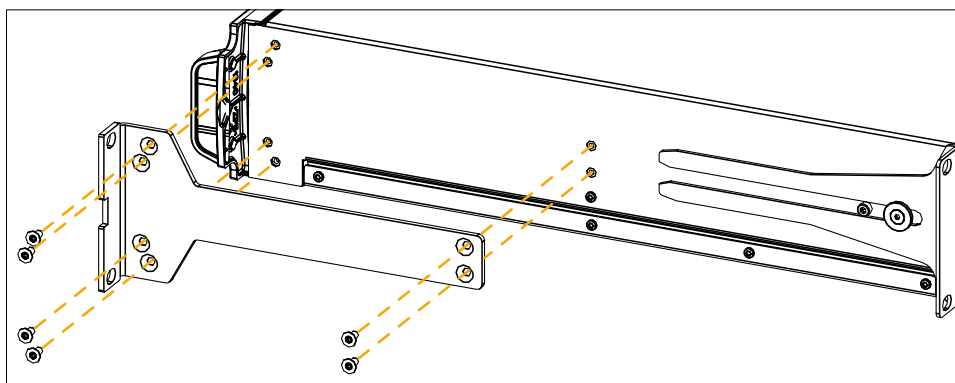

Side bracket disassembly procedure

This procedure describes how to remove a side bracket of an LA12X amplified controller.

Procedure

1. Undo the six screws fastening the bracket to the chassis.
Use the electric screwdriver with the T20 Torx bit bit.
2. Remove the side bracket from the amplified controller.

Side bracket reassembly procedure

This procedure describes how to mount a side bracket on an LA12X amplified controller.

Procedure

1. Position the side bracket on the amplified controller.
2. Drive six ISO14581 M4X8 screws into the chassis.
Use the electric screwdriver with the T20 Torx bit bit. Set Torque to 1 N m.

D/R - grill and foam filter

This procedure describes how to replace the grill and foam filter of an LA12X amplified controller.

Tools

Name	Reference	Distributor
3.5 mm flat screwdriver	AN3,5X100	FACOM

Repair kits

Name	Designation	Qty
KR LA4XGRI	LA4X grills	1

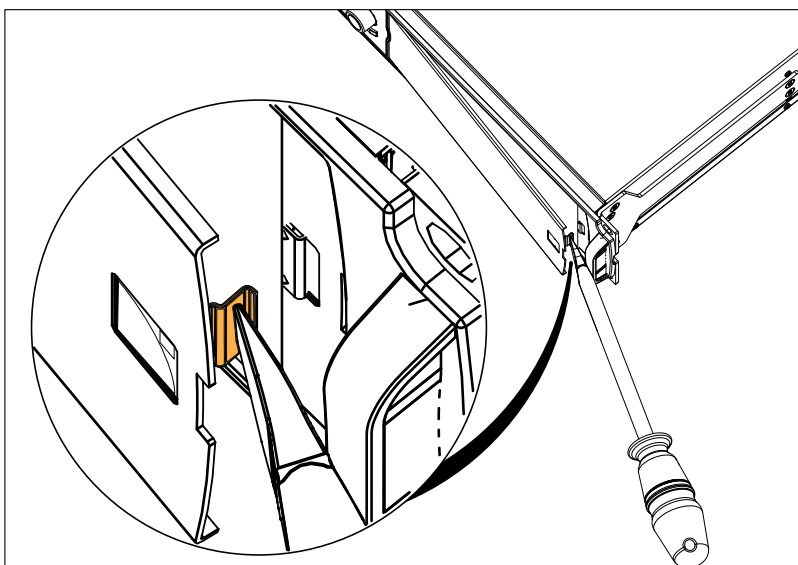

Grill and foam filter disassembly procedure

This procedure describes how to remove the grill and foam of an LA12X amplified controller.

Procedure

1. Insert the head of the screwdriver in the notch on the right side of the grill.
2. Push the internal latch with the screwdriver and pull out the right side of the grill.
3. Push the internal latch with the screwdriver again until the latch comes out.
4. Remove the grill and the foam filter from the amplified controller.
5. If the foam filter is to be cleaned: use mild dishwashing detergent or soap then dry it.

Grill and foam filter reassembly procedure

This procedure describes how to mount the grill and foam filter on an LA12X amplified controller.

Procedure

1. If reassembling a new grill, stick CT LOGO3 to the grill.
2. Place a foam filter into the grill.
3. Insert the left side of the grill into the amplified controller.
4. Insert the internal latch into the amplified controller.
Use the screwdriver.
5. Push on the right side of the grill until hearing a click sound.

D/R - rear bracket

This procedure describes how to replace a rear bracket of an LA12X amplified controller.

Tools

Name	Reference	Distributor
electric screwdriver with torque selector	-	-
T30 Torx bit	EX.630	FACOM

Repair kits

Name	Designation	Qty
KR LABRACKET	Kit rear brackets for LA4/LA4X/LA8	1

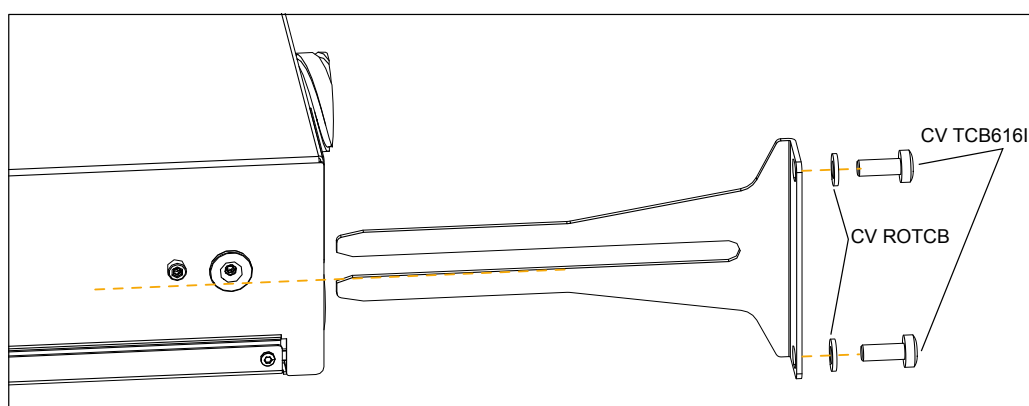

Rear bracket disassembly procedure

This procedure describes how to remove a rear bracket of an LA12X amplified controller.

Procedure

Pull on the rear bracket until it is removed from the amplified controller.

Rear bracket reassembly procedure

This procedure describes how to mount a rear bracket on an LA12X amplified controller.

Procedure

1. Insert the rear bracket.
2. Push on the rear bracket until locked.
3. To fix the bracket to a rack frame, use two CV TCB616I and two CV ROTCB.
Use the electric screwdriver and the Torx T30 bit. Set torque to 3 N.m.

Glossary

CE	Europe
CHK	check procedure
CN	China
D/R	disassembly/reassembly procedure
INSP	inspection procedure
INT	international (bare lead version of the power cable)
KR	repair kit
N.m	newton meter, international torque unit, 1 N.m = 9 in lbf
SMPS	Switched Mode Power Supply (power supply inside of the amplified controller)
US	United States

Specifications

All values given in this section are typical values.

General

output power CEA-2006 / 490A (1% THD, 1 kHz, all channels driven)	4 x 1400 W RMS (at 8 Ω) 4 x 2600 W RMS (at 4 Ω) 4 x 3300 W RMS (at 2.7 Ω)
amplification class	Class D
Digital Signal Processor (DSP)	2 x SHARC 32-bit, floating point, 96 kHz sampling rate
frequency response 20 Hz - 20 kHz	\pm 0.1 dB (at 8 Ω , 60 W output power) \pm 0.1 dB (at 4 Ω , 120 W output power)
distortion THD+N (20 Hz - 10 kHz)	< 0.05% (at 8 Ω , 60 W output power) < 0.1% (at 4 Ω , 120 W output power)
output dynamic range (20 Hz - 20 kHz, 8 Ω , A-weighted)	> 114 dB
amplification gain	32 dB
noise level (20 Hz - 20 kHz, 8 Ω , A-weighted)	< -72 dBV
channel separation (at 1 kHz, 3 x 120 W, 4 Ω)	> 85 dB
damping factor	> 400 (1 kHz and below, 8 Ω)
output delay	0 ms to 1000 ms

mains input power and current draw (all channels driven)

	4 x 1400 W RMS at 8 Ω	4 x 2600 W RMS at 4 Ω	4 x 3300 W RMS at 2.7 Ω
maximum output power	4 x 1400 W RMS at 8 Ω	4 x 2600 W RMS at 4 Ω	4 x 3300 W RMS at 2.7 Ω
1/3 output power (-5dB)	10.5 A / 2300 W	19 A / 4200 W	26 A / 5500 W
1/8 output power (-9 dB)	4.8 A / 1050 W	8.1 A / 1850 W	11.5 A / 2400 W
idle	1 A / 160 W	1 A / 160 W	1 A / 160 W
standby	0.6 A / 10 W	0.6 A / 10 W	0.6 A / 10 W

Current values given for mains rated at 230 V. Multiply by:

- 2.3 for 100 V
- 1.9 for 120 V
- 1.15 for 200 V

power supply

model	universal Switched Mode Power Supply (SMPS) with power factor correction (PFC)
power factor	> 0.9 (except Standby on all voltages, and Idle on 230 V)
mains rating	100 V - 240 V \sim \pm 10%, 50-60 Hz
nominal current requirements	30 A for 100-120 V, 16 A for 200-240 V

operating conditions

temperature	room temperature (from 0° C / 32° F to +50° C / 122° F)
-------------	---------------------------------------------------------

protection

mains and power supply	over and under voltage over temperature overcurrent (fuse protection, and inrush current protection)
power outputs	over current DC short circuit rail over and under voltage over temperature
transducers protection	L-DRIVE: excursion temperature over-voltage
cooling system	fans with temperature-controlled speed

interface and connections

indicators	3 x LEDs for power, status and L-NET information For each output: 7 x LEDs for mute, load, signal, levels and limit/clip information
interface	2 x 24 characters LCD screen
output connectors	2 x 4-point speakON® 1 x 8-point CA-COM
L-NET connectors	2 x 1 Gb/s Ethernet etherCON®

Input Signal distribution**connectors**

input	4 Neutrik® female XLR3, IEC 60268-12, ESD protected
link	4 Neutrik® male XLR3, IEC 60268-12, ESD protected

Neutrik, speakON, etherCON and powerCON are registered trademarks of Neutrik AG.

available input connectors vs. input mode

analog AB / analog CD	IN A, IN B / IN C, IN D (4 connectors, 4 channels)
analog AB / digital CD	IN A, IN B / IN C&D (3 connectors, 4 channels)
digital AB / analog CD	IN A&B / IN C, IN D (3 connectors, 4 channels)
digital AB / digital CD	IN A&B / IN C&D (2 connectors, 4 channels)

link connectors

analog input mode	passively connected
digital input mode	electronically buffered, failsafe relay

Analog Input

input impedance	22 k Ω (balanced)
max. input level	22 dBu (balanced, THD 1%)
A/D conversion	4 cascaded 24-bit analog/digital converters (130 dB dynamic range)

Digital Input

supported operating mode

standard	AES/EBU (AES3)
sampling frequency (Fs)	44.1, 48, 88.2, 96, 176.4 or 192 kHz
word length	16, 18, 20 or 24 bits
synchronization	signal resampled to internal clock at 96 kHz

Sample Rate Converter (SRC)

sampling frequency	96 kHz (SRC referenced to the amplified controller internal clock)
word length	24 bits
dynamic range	140 dB
distortion (THD+N)	< -120 dBfs
bandpass ripple	\pm 0.05 dB (20 Hz - 40 kHz, 96 kHz)

automatic fallback option

mode	AB to CD digital to analog digital to digital
switchover conditions	no clock, loss of lock, CRC error, bipolar encoding error or data slip
constant delay	independent of input Fs
constant level	upon user setting of AES/EBU gain, independent of input Fs
revert to AES/EBU	upon manual user selection

input gain

range	-12 dB to +12 dB
steps	0.1 dB

Latency

analog and AES/EBU

in standard operating mode	3.84 ms (independent of the input sampling frequency)
in low latency operating mode	0.76 ms (independent of the input sampling frequency)

Remote control and monitoring

network connection	dual-port Ethernet Gigabit interface
L-Acoustics remote control software	LA Network Manager 2
third-party management solutions	SNMP Extron® Crestron®

Extron is a registered trademark of Extron Electronics.

Crestron is a trademark or registered trademark of Crestron Electronics, Inc. in the United States, other countries or both.

Physical data

height	2U
weight	14.5 kg / 32 lb
finish	black
protection rating	IP2x

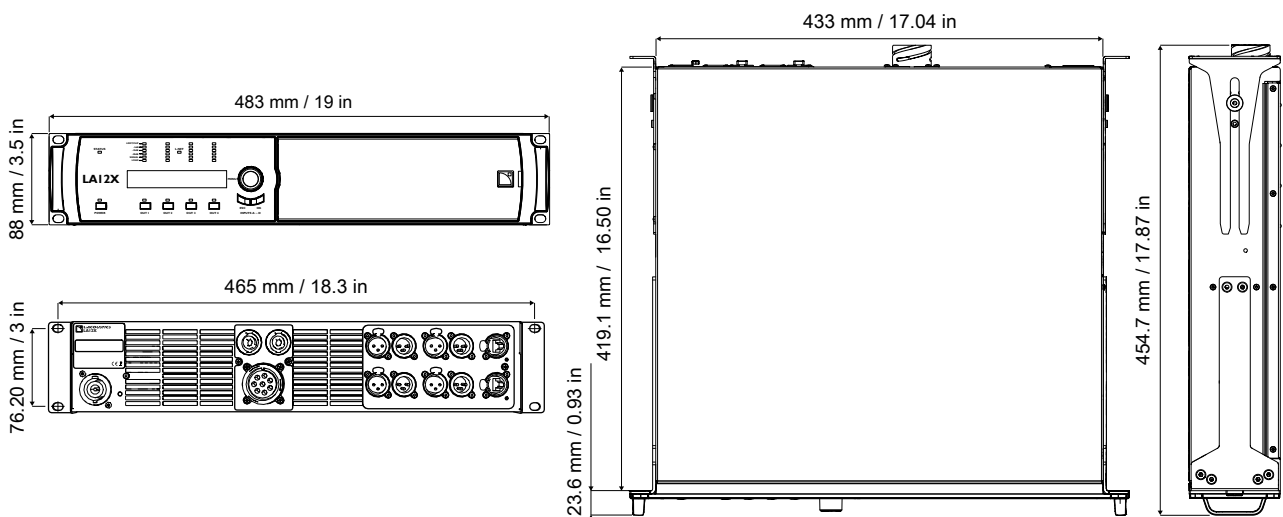

LA12X EC DoC

declaration of conformity - version 1.0



EC declaration of conformity

L-Acoustics

13 rue Levacher Cintrat
Parc de la Fontaine de Jouvence
91462 Marcoussis Cedex
France

states that the LA12X is in conformity with the provisions of:

2014/35/EU: Low Voltage Directive

2014/30/EU: Electro-Magnetic Compatibility Directive

2011/65/EU: RoHS2 Directive

Applied standards:

EN 60065:2002+A1:2006+A11:2008+A2:2010+A12:2011 Safety requirements for audio, video and similar electronic apparatus

EN55032:2015 Electromagnetic compatibility of multimedia equipment – Emission Requirements

EN55103-2 (2009) Electromagnetic compatibility - Product family standard for audio, video, audio-visual and entertainment lighting control apparatus for professional use - Part 2: Immunity

CE marking date: 2016

Issued in Marcoussis, France

21/04/2016

A handwritten signature in black ink, appearing to read "Genio Kronauer".

Genio KRONAUER, Electronics Director

